

FYH[®]

SOPORTES Y RODAMIENTOS AUTOALINEABLES



CAT.NO.3320SF



MÁS LIGEROS Y MÁS RESISTENTES

Los exclusivos soportes
de base sólida de FYH



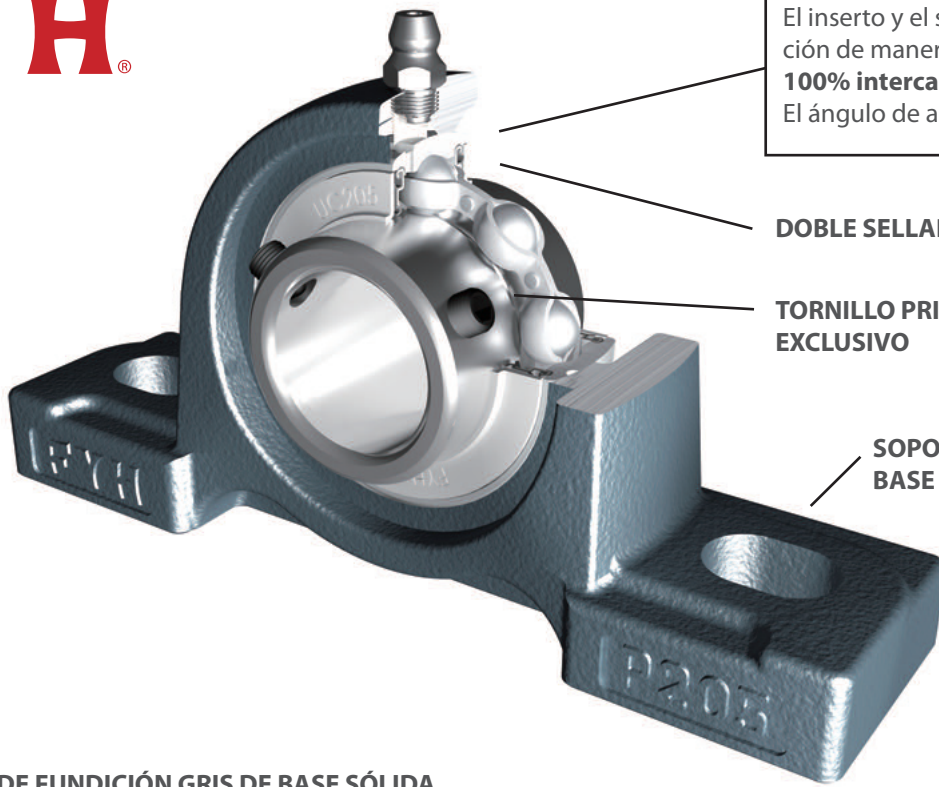

El inserto y el soporte encajan a la perfección de manera que cada rodamiento es **100% intercambiable** con cada soporte. El ángulo de alineación permitido es de 3°.

DOBLE SELLADO DE CONTACTO

TORNILLO PRISIONERO DE DISEÑO EXCLUSIVO

SOPORTE DE FUNDICIÓN GRIS DE BASE SÓLIDA

SOPORTE DE FUNDICIÓN GRIS DE BASE SÓLIDA



Los exclusivos soportes de base sólida de FYH apoyan mejor y forman un conjunto más estable que reduce considerablemente las vibraciones. Los nervios de soporte han sido eliminados para dejar más espacio a los tornillos y a las arandelas, aun así son más del 30% más fuertes que antes y además tienen la ventaja de un peso reducido.

DOBLE SELLADO DE CONTACTO

El sellado FloBack tiene una serie de características que hacen que la vida de los rodamientos sea más larga en comparación con los diseños de la competencia. Consiste en un sellado de doble labio, fijado al anillo exterior para reducir la posibilidad de ser empujado hacia fuera por la excesiva lubricación. El primer sellado entra en contacto con la parte interna del deflector que es la primera línea de defensa contra la contaminación. El siguiente entra en contacto con el anillo interior para otro nivel más de resistencia contra la contaminación. Existe también un nivel adicional de protección que es el labio complementario sin contacto, girado hacia dentro, que permite al lubricante fluir de vuelta a las bolas y a las pistas de rodadura durante el funcionamiento, mejorando así la lubricación y prolongando la vida de los rodamientos. El sellado FloBack de FYH permite una excelente redondez del anillo exterior del rodamiento, facilitando su adaptación a todos los soportes y configuraciones de montaje. La velocidad de rotación permitida es la misma que en el anterior sellado.



TORNILLO PRISIONERO DE DISEÑO EXCLUSIVO



El exclusivo Bullet Point de FYH es un tornillo prisionero de una pieza, diseñado para expandir su rosca cuando la punta entra en contacto con el eje. La expansión proporciona una mejor capacidad de sujeción y reduce la posibilidad de dañar el eje que existe con los tornillos prisionero tradicionales.

FYH® Lubricante de Litio para Rodamientos

El Lubricante de Litio para Rodamientos de FYH es el complemento perfecto para el diseño específico de los Rodamientos FYH: funciona bien en una amplia gama de condiciones de trabajo. Se puede mezclar con otros tipos de lubricantes de FYH, incluido el jabón de litio Gold 3A, ya que mejorará el rendimiento, la resistencia a la corrosión y la capacidad de carga, y prolongará la vida de los rodamientos. El Lubricante de Litio para Rodamientos de FYH también está disponible en lubricadores automáticos.



GUÍA DE SELECCIÓN

1. Seleccione el soporte que mejor se adapta a su aplicación.

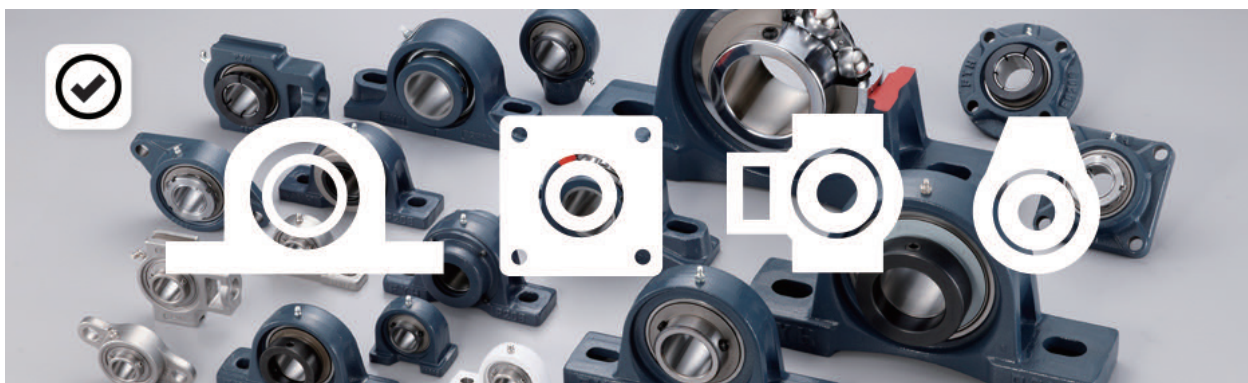

P - SOPORTE DE APOYO **PA** - BASE CORTA **PH** - CENTRO DE EJE ELEVADO **LP** - LIGERO **IP** - GRUESO **PP** - DE CHAPA DE ACERO
F - SOPORTE-BRIDA DE 4 AGUJEROS **FS** - CUADRADO CON RESALTE DE CENTRAJE
FL - SOPORTE-BRIDA DE 2 AGUJEROS **LF** - LIGERO **PFL** - DE CHAPA DE ACERO **FA** - AJUSTABLE
FB - SOPORTE-BRIDA DE 3 AGUJEROS
FC - SOPORTE-BRIDA DE 4 AGUJEROS DE TIPO CARTUCHO
T - SOPORTE TENSOR
C - SOPORTE CARTUCHO
H - SOPORTE COLGANTE

2. Seleccione el diámetro del eje y la carga de su aplicación.



SU - DIÁMETRO INTERNO DESDE 10 MM HASTA 30 MM
SA & SB - DIÁMETRO INTERNO DESDE 12 MM Y 1/2" HASTA 40 MM Y 1-9/16"
UC - DIÁMETRO INTERNO DESDE 12 MM Y 1/2" HASTA 140 MM
NA - DIÁMETRO INTERNO DESDE 12 MM Y 1/2" HASTA 75 MM Y 3"
NC - DIÁMETRO INTERNO DESDE 20 MM Y 3/4" HASTA 60 MM Y 2-7/16"
UK - DIÁMETRO INTERNO DESDE 20 MM Y 3/4" HASTA 120 MM

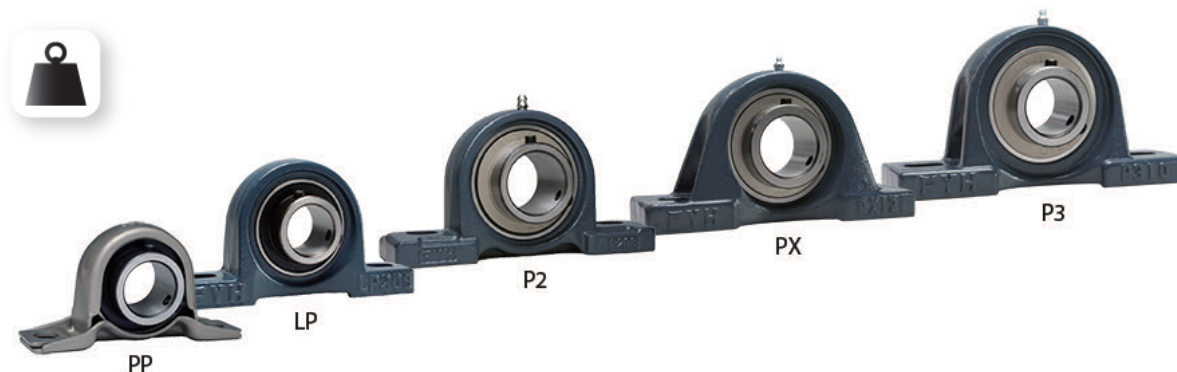

LIGERA	NORMAL	MEDIA	PESADA
--------	--------	-------	--------

3. ¿Necesita personalizar el rodamiento para su aplicación? Seleccione ESTÁNDAR para la opción predeterminada.



TEMP - **D2K2** DE -58°F A 248°F (DE -50°C A 120°C), **D1K2** DE -40°F A 356°F (DE -40°C A 180°C), **D9K2** DE -4°F A 446°F (DE -20°C A 230°C)
LAVADO - SOPORTES DE ACERO INOXIDABLE, SOPORTES DE PLÁSTICO
TRATAMIENTO DEL AIRE - **S3** SOPORTES APTOS PARA EL TRATAMIENTO DEL AIRE, **S5** SELLADO SIN CONTACTO
POLVO - **L3** SELLADO DE TRIPLE LABIO, **K9** OBTURACIÓN DE FIELTRO, TAPAS
SUCIEDAD - **LT3** SELLADO DE TRIPLE LABIO AJUSTADO, TAPAS

4. Seleccione el tipo de fijación para su inserto.



UC - TORNILLO PRISIONERO
NA - ANILLO DE FIJACIÓN EXCÉNTRICO
NC - ANILLO DE FIJACIÓN CONCÉNTRICO
UK - MANGUITO DE FIJACIÓN

5. SU SOPORTE





ESTÁNDAR

1 Tipos

1.1 Tipos y características

Los Soportes para Rodamientos FYH están disponibles en una gran variedad de estilos y tamaños. Los diferentes tipos y sus características están detallados a continuación.

Nota ¹⁾ Los códigos de los soportes con tapas están indicados en la siguiente tabla. (la misma para todos los tipos)

Serie de diámetro	Código	Descripción
2	C, CD	Con tapa de chapa de acero
	FC, FCD	Con tapa de fundición gris
X	C, CD	De X05 a X17: Con tapa de chapa de acero X18 y X20: Con tapa de fundición gris
	C, CD	Con tapa de fundición gris

1 Soportes de apoyo

1 Soportes de apoyo



UCP



NAP

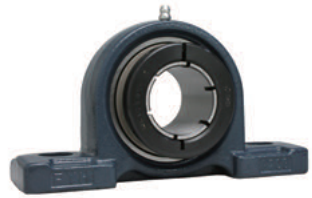

NCP



UKP

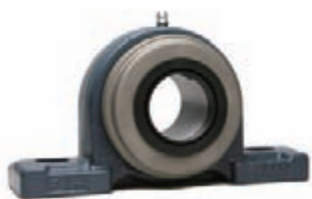

UCP-C, CD
UKP-C, CD



UCP-FC, FCD
UKP-FC, FCD

UCP es un soporte rígido de fundición gris, cuyo anillo interior está dotado de dos tornillos prisioneros especialmente diseñados y espaciados a 120° para maximizar su capacidad de sujeción y su resistencia en una amplia gama de aplicaciones y condiciones de trabajo.

NAP es un soporte con un inserto dotado de anillo de fijación excéntrico que proporciona una sujeción muy segura del eje que aumenta a medida que va funcionando. Está diseñado específicamente para rotaciones en una sola dirección.

NCP es un soporte con un anillo de fijación concéntrico especialmente diseñado para proporcionar un contacto de 360° con el eje. Lo sujeta de manera más concéntrica respecto a otros sistemas de fijación y funciona muy bien con aplicaciones de alta velocidad.

UKP es un soporte con un inserto de rodamientos de agujero cónico que utiliza manguito de fijación para proporcionar al eje una sujeción concéntrica y extremadamente segura, y para reducir el deslizamiento y la corrosión por desgaste, incluso en condiciones adversas.

Carga: Estándar, Media, Pesada

2 Soportes de apoyo gruesos

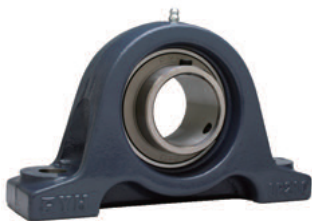

UCIP

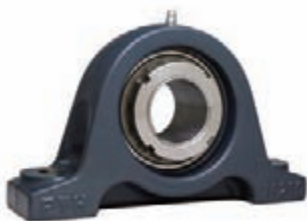

UKIP

UCIP es un soporte extremadamente rígido y resistente para aplicaciones que requieren un mayor aguante. Los agujeros para los tornillos son redondos para extremar la precisión a la hora de colocarlo y su resistencia nominal es considerablemente mayor respecto a los soportes de apoyo estándar.

Carga: Estándar, Pesada

3 Soportes de apoyo con base corta



UCPA

UCPA es un soporte con base corta dotado de agujeros roscados en la parte baja. Es ideal para espacios limitados y para aplicaciones que requieren una colocación muy precisa. Está disponible con el tamaño de los agujeros tanto en milímetros como en pulgadas.

Carga: Estándar

4 Soportes de apoyo con centro de eje elevado



UCPH

UCPH es un soporte con un centro de eje excepcionalmente elevado. Es ideal para aplicaciones en las que un eje escalonado pudiera crear interferencia con la superficie de montaje en el caso de que se utilizara un soporte estándar.

Carga: Estándar

5 Soportes de apoyo ligeros



BLP

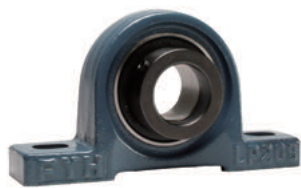

ALP

BLP es un soporte compacto y ligero que es ideal para espacios limitados y para aplicaciones que requieren una carga ligera o moderada. También está disponible el modelo **ALP** con anillo de fijación excéntrico SA.

Carga: Ligera

6 Soportes de apoyo compactos



UP



UP-C, CD

UP es un soporte para cargas ligeras que pertenece a la Serie Limpia. Está fabricado con una aleación de zinc y por lo tanto tiene una alta resistencia a la corrosión. También admite el cierre con tapas que contribuyen a aumentar su resistencia a la contaminación.

Carga: Ligera

7 Soportes de apoyo a prueba de corrosión



UCSP-H1S6



USP-S6

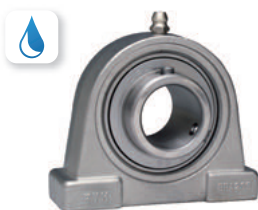

UCSPA-H1S6



UCVP-S6

UCSP es un soporte cuyos componentes están fabricados en acero inoxidable, de manera que posee el nivel más alto de resistencia a la corrosión. Además está previamente rellenado con grasa apta para el uso en aplicaciones de la industria alimentaria.

UCSPA es un soporte con base corta dotado de agujeros roscados en la parte baja. Sus componentes están fabricados en acero inoxidable de manera que posee el nivel más alto de resistencia a la corrosión. Es ideal para espacios limitados y para aplicaciones que requieren una colocación muy precisa. Además está previamente rellenado con grasa apta para el uso en aplicaciones de la industria alimentaria.

UCVP es un soporte termoplástico resistente a la corrosión que admite tanto los insertos de acero inoxidable como los laminados con cromato de zinc. Ambos son altamente resistentes a la corrosión y están lubricados con grasa apta para el uso alimentario.

Carga: Ligera, Estándar

8 Soportes de chapa de acero



SBPP



SAPP

SBPP es un soporte de chapa de acero, ligero y compacto, apto para aplicaciones que requieren una carga ligera o moderada. También está disponible el modelo **SAPP** con anillo de fijación excéntrico SA.

Carga: Ligera

2 Soportes-brida de 4 agujeros

1 Soportes-brida de 4 agujeros



UCF



UKF

UCF es un soporte-brida rígido de fundición gris, cuyo anillo interior está dotado de dos tornillos prisioneros especialmente diseñados y espaciados a 120° para maximizar su capacidad de sujeción y su resistencia en una amplia gama de aplicaciones y condiciones de trabajo.

También está disponible el modelo UK.

Carga: Estándar, Media, Pesada

2 Soportes-brida de 4 agujeros con resalte de centrado



UCFS



UKFS

UCFS es un soporte-brida disponible con un inserto para cargas pesadas, para entornos de trabajo exigentes. El resalte de centrado en la parte trasera del soporte permite un montaje muy preciso en el caso de que fuera necesario.

También está disponible el modelo UK.

Carga: Pesada

3 Soportes-brida de 4 agujeros a prueba de corrosión



UCSF-H1S6



UCVF-S6

UCSF es un soporte-brida cuyos componentes están fabricados en acero inoxidable, de manera que posee el nivel más alto de resistencia a la corrosión. Además está previamente relleno con grasa apta para el uso en aplicaciones de la industria alimentaria.

UCVF es un soporte-brida termoplástico resistente a la corrosión que admite tanto los insertos de acero inoxidable como los laminados con cromato de zinc. Ambos son altamente resistentes a la corrosión y están lubricados con grasa apta para el uso alimentario.

Carga: Estándar

3 Soportes-brida ovalados

1 Soportes-brida de 2 agujeros



UCFL



UKFL

UCFL es un soporte-brida rígido de fundición gris, cuyo anillo interior está dotado de dos tornillos prisioneros especialmente diseñados y espaciados a 120° para maximizar su capacidad de sujeción y su resistencia en una amplia gama de aplicaciones y condiciones de trabajo. También está disponible el modelo UK.

Carga: Estándar, Media, Pesada

2 Soportes-brida ajustables de 2 agujeros



UCFA

UCFA es un soporte-brida ajustable de fundición gris cuyo anillo interior está dotado de dos tornillos prisioneros especialmente diseñados y espaciados a 120° para maximizar su capacidad de sujeción y su resistencia en una amplia gama de aplicaciones y condiciones de trabajo.

Carga: Estándar

3 Soportes-brida de 3 agujeros



UCFB

UCFB es un soporte-brida rígido de fundición gris, cuyo anillo interior está dotado de dos tornillos prisioneros especialmente diseñados y espaciados a 120° para maximizar su capacidad de sujeción y su resistencia en una amplia gama de aplicaciones y condiciones de trabajo. Está disponible con el tamaño de los agujeros en milímetros y en pulgadas.

Carga: Estándar

4 Soportes-brida ligeros de 2 agujeros



BLF



ALF

BLF es un soporte-brida ligero y compacto que es ideal para espacios limitados y para aplicaciones que requieren una carga ligera o moderada. También está disponible el modelo **ALF** con anillo de fijación excéntrico SA.

Carga: Ligera

5 Soportes-brida compactos de 2 agujeros



UFL



UFL-C, D

UFL es un soporte-brida para cargas ligeras que pertenece a la Serie Limpia. Está fabricado con una aleación de zinc y por lo tanto tiene una alta resistencia a la corrosión. También admite el cierre con tapas que contribuyen a aumentar su resistencia a la contaminación.

Carga: Ligera

6 Soportes-brida de 2 agujeros a prueba de corrosión



UCSFL-H1S6



USFL-S6

UCSFL es un soporte-brida cuyos componentes están fabricados en acero inoxidable, de manera que posee el nivel más alto de resistencia a la corrosión. Además está previamente relleno con grasa apta para el uso en aplicaciones de la industria alimentaria.

Carga: Ligera, Estándar

7 Soportes-brida de 2 agujeros de chapa de acero



SBPFL



SAPFL

SBPFL es un soporte-brida de chapa de acero, ligero y compacto, apto para aplicaciones que requieren una carga ligera o moderada. También está disponible el modelo **SAPFL** con anillo de fijación excéntrico SA.

Carga: Ligera

4 Soportes-brida de 4 agujeros de tipo cartucho

1 Soportes-brida de 4 agujeros de tipo cartucho



UCFC



UKFC

UCFC es un soporte-brida rígido de tipo cartucho, de fundición gris, cuyo anillo interior está dotado de dos tornillos prisioneros especialmente diseñados y espaciados a 120° para maximizar su capacidad de sujeción y resistencia en una amplia gama de aplicaciones y condiciones de trabajo. El resalte de centrado en la parte trasera permite un montaje muy preciso en el caso de que fuera necesario. También están disponibles los modelos UK y NA.

Carga: Estándar, Media

5 Soportes tensores

1 Soportes tensores



UCT



UKT

UCT es un soporte tensor de ranura ancha, apto para marcos tensores de montaje lateral. Fabricado en fundición gris, su anillo interior está dotado de dos tornillos prisioneros especialmente diseñados y espaciados a 120° para maximizar su capacidad de sujeción y su resistencia en una amplia gama de aplicaciones y condiciones de trabajo.

También está disponible el modelo UK.

Carga: Estándar, Media, Pesada

2 Soportes tensores a prueba de corrosión



UCST-H1S6

UCST es un soporte tensor cuyos componentes están fabricados en acero inoxidable, de manera que posee el nivel más alto de resistencia a la corrosión. Además está previamente relleno con grasa apta para el uso en aplicaciones de la industria alimentaria.

Carga: Estándar

6 Otros soportes

1 Soportes cartucho



UCC



UKC

UCC es un soporte cartucho cuyo anillo interior está dotado de dos tornillos prisioneros especialmente diseñados y espaciados a 120° para maximizar su capacidad de sujeción y su resistencia en una amplia gama de aplicaciones y condiciones de trabajo. El cartucho permite mucha precisión a la hora de montar el eje y capacidad de expansión. También están disponibles los modelos UK, NA y NC.

Carga: Estándar, Media, Pesada

2 Soportes colgantes



UCHA

UCHA es un soporte colgante con base roscada para una instalación sencilla en una configuración de tuberías roscadas. Su anillo interior está dotado de dos tornillos prisioneros especialmente diseñados y espaciados a 120° para maximizar su capacidad de sujeción y su resistencia en una amplia gama de aplicaciones y condiciones de trabajo.

Carga: Estándar

7 Rodamientos de bolas

1 Inserto tipo UC



UC



UC-L3



UC-S6

Agujero cilíndrico (con tornillos prisioneros)

UC2 (X, 3)...Tipo estándar Carga: Estándar, Media, Pesada

UC2 (X, 3) L3...Tipo con sellado de triple labio

UC2-S6...Serie de acero inoxidable Carga: Estándar

Este rodamiento rígido de bolas con sello de grasa tiene un anillo exterior con una superficie externa esférica y una ranura de relubricación, y un ancho anillo interior con agujero cilíndrico y tornillos prisioneros. Están disponibles dos modelos, según el tipo de sellado: estándar (retén de aceite y deflector incluidos) y con sellado de triple labio (código suplementario: L3).

Se fija al eje apretando los dos tornillos prisioneros en el anillo interior. Es el modelo más común entre los rodamientos de bolas. La serie UC2-S6 está compuesta por rodamientos de nivel superior, a prueba de agua y corrosión. Están fabricados en acero inoxidable y se utilizan para las series de soportes inoxidables. Para los tipos y las características de los tornillos prisioneros de los rodamientos UC, ver **"Cat.No.3320 14 Handling"**.

2 Inserto tipo NC



NC

Agujero cilíndrico (con anillo de fijación concéntrico)

NC2 Carga: Estándar

Los rodamientos NU-LOC de FYH sujetan el eje de manera más uniforme a través de un contacto de 360°. La precisión de giro da como resultado un mejor funcionamiento y una vida más larga. Los anillos de fijación concéntricos NU-LOC están diseñados para evitar que los ejes se dañen o desgasten.

El único tornillo estándar de cabeza hexagonal se aprieta rápida y fácilmente. Los rodamientos NU-LOC pueden sustituir tanto los insertos con tornillos prisioneros como los de anillo de fijación excéntrico.

3 Inserto tipo UK



UK



UK+H

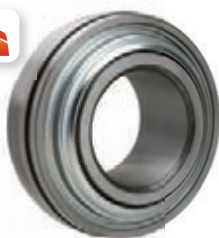

UK-L3



UK-L3+H

Agujero cónico (con manguito de fijación)

UK2 (X, 3)...Tipo estándar Carga: Estándar, Media, Pesada

UK2 (3) L3...Tipo con sellado de triple labio

Este modelo de rodamiento rígido de bolas con sello de grasa tiene un anillo exterior con una superficie externa esférica y una ranura de relubricación, y un ancho anillo interior con agujero cónico. Están disponibles dos modelos, según el tipo de sellado: estándar (retén de aceite y deflector incluidos) y con sellado de triple labio (código suplementario: L3).

Se fija al eje con un manguito de fijación. Los tipos de rodamientos UK (con manguito) son ideales para los ejes largos. Para este tipo de inserto, se añade a la referencia del rodamiento la del manguito apropiado.

(7 Rodamientos de bolas)

4 Inserto tipo NA



NA

Agujero cilíndrico (con anillo de fijación excéntrico)

NA2

Carga: Estándar, Pesada

Este modelo se basa en el UC que tiene tornillos prisioneros, pero está dotado de anillo de fijación excéntrico. Este rodamiento rígido de bolas tiene un anillo exterior con una superficie externa esférica y una ranura de relubricación, un ancho anillo interior con agujero cilíndrico, y un anillo de fijación excéntrico con una sección excéntrica a un lado. El dispositivo de sellado incluye retén de aceite y deflector.

Para fijar el rodamiento al eje, acoplar la sección excéntrica rebajada del anillo de fijación excéntrico a la sección excéntrica del anillo interior, girar el anillo de fijación excéntrico para ajustarlo al eje, y apretar el tornillo prisionero.

5 Inserto tipo SB



SB

Agujero cilíndrico (con tornillos prisioneros)

SB2

Carga: Ligera

Ésta es la versión ligera del modelo UC. Este rodamiento rígido de bolas, sin ranura de relubricación y con sello de grasa, tiene un anillo exterior con una superficie externa esférica y un ancho anillo interior con agujero cilíndrico y tornillos prisioneros. Para fijarlo al eje, apretar los dos tornillos prisioneros del anillo interior. Se utiliza para los soportes ligeros o para los de chapa de acero.

6 Inserto tipo SA



SA

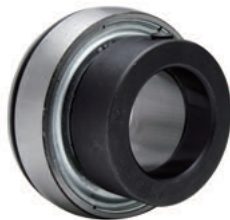

SA-F

Agujero cilíndrico (con anillo de fijación excéntrico)

SA2, SA2-F

Carga: Ligera

Este modelo se basa en el SB que tiene tornillos prisioneros, pero está dotado de anillo de fijación excéntrico. Este rodamiento rígido de bolas, sin ranura de relubricación y con sello de grasa, tiene un anillo exterior con una superficie externa esférica, un ancho anillo interior con agujero cilíndrico, y un anillo de fijación excéntrico con una sección excéntrica a un lado.

Para fijar el rodamiento al eje, acoplar la sección excéntrica rebajada del anillo de fijación excéntrico a la sección excéntrica del anillo interior, girar el anillo de fijación excéntrico para ajustarlo al eje y apretar el tornillo prisionero.

(El tipo SA-F tiene una ranura de relubricación en el anillo exterior.)

Se utiliza para los soportes ligeros o para los de chapa de acero.

7 Inserto tipo SU (Serie Limpia)



SU



SU-S6

Agujero cilíndrico (con tornillos prisioneros)

SU0... Tipo estándar

Carga: Ligera

SU0-S6... Acero inoxidable

Esta serie de rodamientos, diseñada para carga ligera, es ideal para reducciones de tamaño y de peso.

Este rodamiento rígido de bolas, sin ranura de relubricación y con sello de grasa tiene un anillo exterior con una superficie externa esférica y un ancho anillo interior con agujero cilíndrico y tornillos prisioneros.

Para fijarlo al eje, apretar los tornillos prisioneros en el anillo interior.

El modelo SU0-S6, en acero inoxidable, posee un muy alto nivel de resistencia a la corrosión y se utiliza para soportes de acero inoxidable.

8 Inserto tipo ER



ER



ERC

Agujero cilíndrico (con tornillos prisioneros), superficie externa esférica, ranura de relubricación, anillo elástico con las correspondientes ranuras

ER2, ERC2

Carga: Estándar

Este rodamiento rígido de bolas con sello de grasa tiene una superficie externa esférica con ranura de relubricación y tornillos prisioneros, y un ancho anillo interior con agujero cilíndrico y tornillos prisioneros. Para fijarlo al eje, apretar los dos tornillos prisioneros del anillo interior. Está dotado de ranura de relubricación, tornillos prisioneros (rodamiento fácil de colocar), ajuste holgado entre el anillo interior y el eje (fácil ER ERC de instalar). Por lo tanto, se le pueden dar usos diferentes, de manera similar a los rodamientos estándar.

También está disponible el tipo ERC con anillo concéntrico.

9 Inserto tipo RB

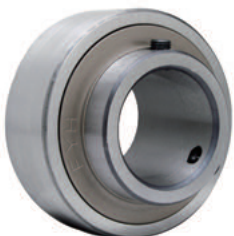

RB

Agujero cilíndrico (con tornillos prisioneros), superficie externa esférica

RB2

Carga: Estándar

Este modelo se basa en el ER, pero no tiene ranura de relubricación ni anillo elástico. Este rodamiento rígido de bolas con sello de grasa tiene un anillo exterior con superficie externa esférica y un ancho anillo interior con agujero cilíndrico y tornillos prisioneros. Para fijarlo al eje, apretar los dos tornillos prisioneros del anillo interior. Como se utiliza el ajuste holgado para fijar el anillo interior al eje (fácil de instalar), se le pueden dar usos diferentes, de manera similar a los rodamientos estándar.



TEMP

Serías aptas para Temperaturas Altas / Bajas

(códigos sufijos - Temperatura alta: D1K2 y D9K2 Temperatura baja: D2K2)

Para aplicaciones que requieren que los rodamientos se utilicen a temperaturas más altas o más bajas que las de los modelos estándar, FYH ofrece varias opciones. Para los soportes aptos para altas temperaturas que necesitan lubricación, colocar el sufijo D1K2 junto al número estándar. Para los soportes aptos para altas temperaturas que no requieren lubricación, el sufijo es D9K2.

Para el inserto D9K2 se utiliza una grasa fluorada que proporciona una excelente resistencia al calor y un funcionamiento con una manutención mínima.

Las especificaciones de los soportes aptos para temperaturas altas y bajas están indicadas en la **Tabla**.



Tabla Especificaciones de las Series aptas para Temperaturas Altas / Bajas

Especificaciones de las Series aptas para Temperaturas Altas / Bajas								
Categoría	Código especial	Rango de temperaturas de funcionamiento		Lubricante	Material del sellado de goma	Juego radial del rodamiento		
		(°C)	(°F)			mod. UC	mod. UK	
Estándar	-	-20 to 100	-4 to 212	Lubricante de rodamientos de litio FYH (jabón de complejo de litio)	Nitrilo	CN	C3	
Resistente al frío	D2K2	-50 to 120	-58 to 248	SH33M (jabón de litio)	Silicona	CN	C3	
Resistente al calor	D1K2	-40 to 180	-40 to 356	U-RET EDM-1 (diurea)	Silicona	C4	C5	
Resistente al calor	D9K	-20 to 230	-4 to 446	Demnum L-200 (grasa fluorada)	Silicona	C4	C5	

Especificaciones de la Serie apta para Temperaturas Extremadamente Altas								
Categoría	Código especial	Rango de temperaturas de funcionamiento		Lubricante	Material del sellado de goma	Juego radial del rodamiento		
		(°C)	(°F)			mod. UC	mod. UK	
Resistente al calor	D9P4Y2	-20 to 260	-4 to 500	Demnum L-200 (grasa fluorada)	-	C4	-	
Resist. al calor extremo	S6Y3	300 to 450	572 to 842	Lubricante de grafito sólido	-	Especial	-	

Frecuencia de lubricación de los rodamientos de bolas							
Temperatura de funcionamiento (°C)		Intervalos de lubricación			Rodamientos utilizados	Grasa suministrada	
Desde	Hasta	Sostancialmente limpio	Polvo excesivo	Polvo excesivo y humedad			
	50	(3 meses) no necesario	(2 meses) 1 año	(1 mes) 4 meses	(D2K2 para temp. bajas) ¹⁾ Rodamientos estándar	SH33M Lubricante de litio de rodamientos FYH	
50	70	1 año	4 meses	1 mes			
70	100	6 meses	2 meses	2 semanas			
100	120	2 meses	2 semanas	5 días	D1K2 para temperaturas altas	U-RET EDM-1	
120	150	2 semanas	5 días	2 días			
150	180	1 semana	2 días	1 día			

Note 1) Los intervalos de lubricación en paréntesis se refieren a las grasas para temperaturas bajas (D2K2). Los intervalos de lubricación indicados en la tabla se refieren a soportes operativos de 8 a 10 horas al día. Si el funcionamiento tiene una duración mayor, se debería especificar un intervalo de lubricación más frecuente. Por ejemplo, si el soporte es operativo de 16 a 20 horas al día, la lubricación deberá ser dos veces más frecuente.





LAVADO

Serie a Prueba de Corrosión

La Serie a Prueba de Corrosión está disponible en una amplia gama de tamaños y estilos, y los soportes se pueden personalizar con una gran variedad de opciones especializadas que los adaptan prácticamente a cualquier aplicación. Los soportes de rodamientos FYH están conformes con las regulaciones más exigentes.



INSERTO INOXIDABLE S6



ANILLOS	Acero inoxidable (equival. SUS 440C)
BOLAS	SUS 440C
JAULA	SUS304
LUBRICANTE	H1 GRADO ALIMENTARIO (FDA /USDA)
OBTURACIÓN	NBR
DEFLECTOR	SUS304
PASADOR ANTI-ROTACIÓN	SUS304
TORNILLOS PRISIONEROS	SUS304
REFERENCIAS	201X - 203X , 204 - 212
JUEGO RADIAL	C3



INSERTO CHAPADO S7



ANILLOS	SUJ2 + (zincado + cromado trivalente)
BOLAS	SUJ2
JAULA	NYLON
LUBRICANTE	H1 GRADO ALIMENTARIO (FDA /USDA)
OBTURACIÓN	NBR
DEFLECTOR	SPCC + (zincado + cromado trivalente)
PASADOR ANTI-ROTACIÓN	SUS304
TORNILLOS PRISIONEROS	SCM435 + (zincado + cromado trivalente)
REFERENCIAS	204 - 210
JUEGO RADIAL	C3



VP VF VFL VPA

Soportes Termoplásticos



Poliéster Termoplástico

H1, H9

Soportes de Acero Inoxidable



Fundición a la cera perdida (equivalente a SUS304 ó 316)

Z5

Soportes Niquelados



Fundición gris + Niquelado





TRATAMIENTO DEL AIRE

Serie apta para el tratamiento del aire

Soportes para sistemas HVAC y tratamiento del aire (código sufijo: S3, S5)

Los soportes de rodamientos para ventiladores tienen que cumplir los requisitos de velocidad de rotación elevada, bajos niveles de vibración y ruido, y una reducida generación de calor. Para cumplir estas expectativas, FYH fabrica las series S3 y S5 con tolerancias reducidas del diámetro interno. S5 utiliza sellado sin contacto y también una optimizada precisión del mecanizado para reducir el calor, el ruido y la vibración.



Aptos para Aplicaciones de Tratamiento del Aire
100% Control de Ruido
P11 El pasador anti-rotación



Aptos para Aplicaciones de Tratamiento del Aire
100% Control de Ruido
P11 El pasador anti-rotación
C2 El juego radial interno es el espacio permitido entre los elementos rodantes y las pistas de rodadura. C2 es una tolerancia menor que la estándar, así que reduce el ruido y las vibraciones en aplicaciones de velocidades elevadas.
P18 P18 es el sufijo que indica una menor tolerancia del diámetro interno que se traduce en una sujeción más ajustada del eje. Esto, a su vez, reduce la vibración y el ruido, y prolonga la vida del rodamiento.
K3 Para un par más bajo, está disponible el sellado de labio sin contacto.

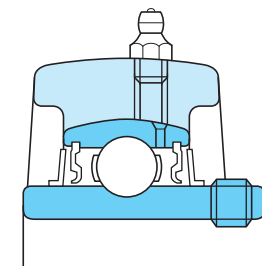



POLVO



SUCIEDAD

Soportes a Prueba de Polvo

Los Soportes a Prueba de Polvo de FYH consisten en una variedad de opciones de sellado suplementarias que protegen de manera muy eficaz de la entrada de agentes externos.

Estas opciones funcionan bien tanto solas como combinadas entre ellas. Desde la industria alimentaria y la agricultura hasta las aplicaciones de lavado y el sector minero, los Soportes a Prueba de Polvo de FYH pueden enfrentarse a los retos de contaminación más difíciles.

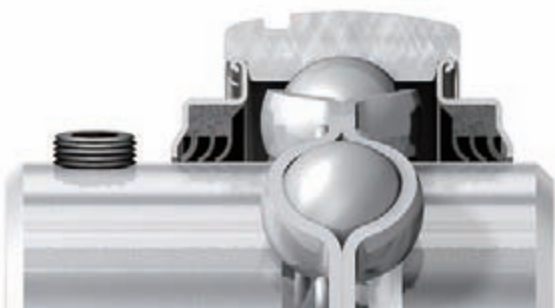

Sellado de Triple Labio (código sufijo: L3)

El L3 consiste en una protección de chapa de acero con un sellado de nitrilo, moldeado de una pieza y con tres labios en su parte interna, que está sujeto al anillo exterior del rodamiento. El sellado de triple labio tiene una excelente resistencia contra cualquier tipo de contaminación y es apto para velocidades bajas y moderadas.

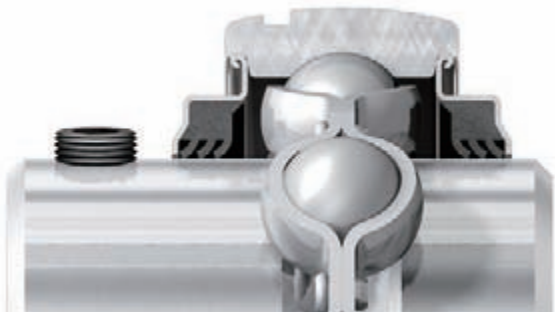

Sellado de Triple Labio ajustado (código sufijo: LT3)

El Sellado de Triple Labio LT3 es más ajustado que el L3. La torsión rotacional en el caso del LT3 es aproximadamente el doble que para el L3 y es apto para ambientes donde la contaminación o la humedad son muy elevadas, y las velocidades de rotación muy reducidas.



Las tapas de chapa de acero y de fundición gris están disponibles en la versión abierta o cerrada, y en una amplia gama de tamaños. Son fáciles de instalar y ofrecen una gran resistencia contra los contaminantes secos y húmedos, los impactos, y el calor. Las tapas protegen el inserto entero de la contaminación y también ayudan a proporcionar un ambiente de trabajo más seguro.

Tapas abiertas de chapa de acero



Tapas abiertas de fundición gris



PROTECCIÓN TRASERA



PROTECCIÓN TRASERA

Las protecciones de goma de nitrilo se pueden montar en la parte trasera de los soportes-brida de dos y cuatro agujeros, y del equipamiento al que están atornillados. La tapa trasera protege sus rodamientos del polvo y de la humedad, y ayuda a prolongar la vida de los rodamientos en aquellas aplicaciones en las que esto puede causar problemas.

La goma de nitrilo para la chapa de acero no tiene ranura de drenaje y está diseñada para proteger contra el polvo. Las aplicaciones donde se puede utilizar este producto incluyen: aplicaciones globales, abonadoras, esparcidores de sal y aplicaciones agrícolas en las que la suciedad puede llegar a la parte trasera de los rodamientos.

La goma de nitrilo para la chapa de acero inoxidable 304, con ranura de drenaje, está diseñada para proteger sus rodamientos en aplicaciones que están expuestas a la humedad y en las que la humedad o el agua acumulada pueden causar problemas. Estas protecciones traseras se pueden utilizar en aplicaciones de la industria alimentaria, sometidas a lavados, así como en aplicaciones farmacéuticas. El núcleo de acero inoxidable es ideal para situaciones en las que el acero normal podría oxidarse rápidamente.



TORNILLO PRISIONERO DE DISEÑO EXCLUSIVO



El innovador tornillo Bullet Point de FYH es un tornillo prisionero de una pieza y de punta redonda, diseñado para expandir su rosca cuando la punta entra en contacto con la superficie del eje.

La fuerza resultante proporciona una capacidad de sujeción superior, sobre todo en presencia de vibraciones. Otros tornillos tienen un área de contacto mayor y bordes afilados en la punta para clavarse en el eje.

Pero estos bordes afilados se dañan fácilmente con las vibraciones, creando un hueco entre la punta del tornillo y el eje. Cuando esto sucede, el tornillo prisionero empieza a soltarse.

Cuando se aprieta el tornillo prisionero Bullet Point, la forma exclusiva de la punta hace que la rosca del tornillo se expanda hasta y más allá del límite elástico para obtener la máxima capacidad de sujeción posible.

Además, la punta tiene un grosor que facilita la expansión. Este diseño particular reduce drásticamente la posibilidad de que el tornillo y el eje sufran daños por el uso normal o por culpa de las vibraciones, la carga de choque y las velocidades elevadas.

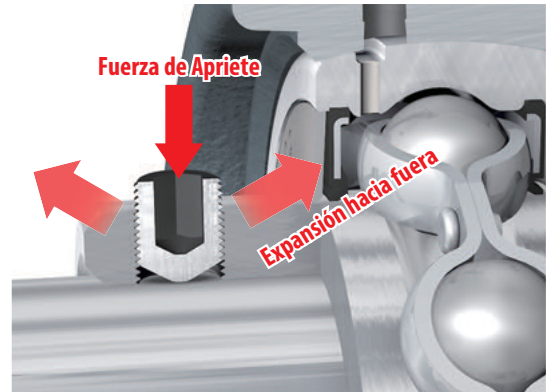

CIERRE CONCÉNTRICO CON 360° DE CONTACTO CON EL EJE

NU-LOC

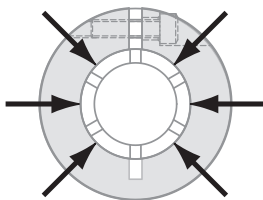

El rodamiento **NU-LOC** de FYH sujeta el eje de manera más uniforme, a través de un contacto de 360°.

Comparado con los rodamientos con tornillos prisioneros, aquí la precisión de giro da como resultado un mejor funcionamiento y una vida más larga.

Los anillos de fijación concéntricos NU-LOC están diseñados para evitar que los ejes se dañen o desgasten. El único tornillo estándar de cabeza hexagonal se puede apretar rápida y fácilmente, y los rodamientos NU-LOC pueden ser una alternativa tanto a los insertos con tornillos prisioneros como a los anillo de fijación excéntrico.

El anillo de fijación concéntrico NU-LOC posee una excelente capacidad de fijación. Se instala en el eje, encima del anillo interior ranurado, de manera concéntrica. Una instalación Fácil y Rápida con un sólo tornillo de cabeza hexagonal.

El nivel de tolerancia de NU-LOC está específicamente diseñado para aplicaciones de velocidades elevadas, mientras que la mayor precisión de giro permite la utilización de un menor juego radial.

También es menor la tolerancia del diámetro interno, ya que NU-LOC tiene un contacto uniforme de 360°. NU-LOC es ideal no sólo para aplicaciones que funcionan con velocidades elevadas, sino para todas en general.

UCP

Agujero cilíndrico (con tornillos prisioneros)
d (45) ~ (75) mm

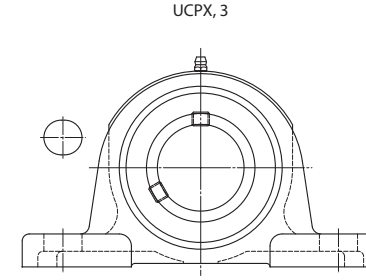
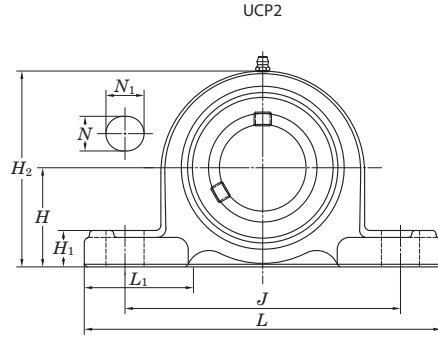
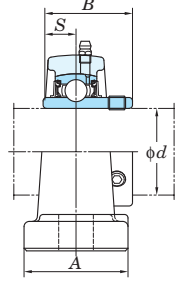

Con tapa de chapa de acero

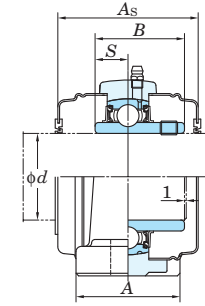

Con tapa de fundición gris

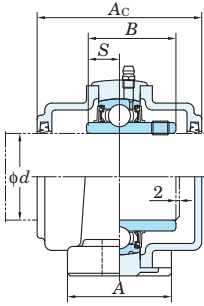

Variaciones en la tolerancia de la distancia entre la base de montaje y el centro del diámetro interno esférico (ΔH_{ts})

Código del Soporte			Unidad: mm
P203~P210	PX05~PX10	P305~P310	±0.15
P211~P218	PX11~PX18	P311~P318	±0.2
	PX20	P319~P328	±0.3

Las formas y las medidas de H_{2c} para P204JE3 y P205JE3 (soporte con tapa de fundición gris) están indicadas abajo.

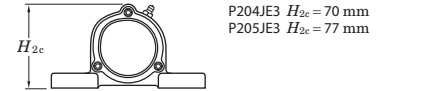

Diámetro del eje mm inch d	Medidas inch mm												Tamaño del tornillo inch mm	Código Unidad	Estándar Código Soporte	Código Rodamiento	Peso kg	Coeficientes Básicos de Carga kN			Factor f ₀	Con tapa de chapa de acero				Con tapa de fundición gris									
	H	L	A	J	N	N ₁	H ₁	H ₂	L ₁	B	S	C _r						C _{0r}	Código Unidad			Medidas		Peso	Código Unidad		Medidas		Peso						
	Mod. abierto	Mod. cerrado por un lado	mm	inch	Mod. abierto	Mod. cerrado por un lado	mm	inch	kg																										
45 1 11/16 1 3/4	2 5/16	8 3/4	2 5/8	6 5/32	25/32	1 5/16	13/16	4 9/16	2 25/32	2.031	0.748	5/8	UCPX09-27 UCPX09-28 UCPX09	PX09	UCX09-27 UCX09-28 UCX09	3.7 3.7 3.7	35.1	23.3	14.4	-	-	-	-	-	-	-	-	-	-	-					
	2 41/64	9 21/32	2 5/8	7 15/32	25/32	1 3/16	13/16	5 3/16	2 15/16	2.244	0.866	5/8	UCP309-28 UCP309	P309	UC309-28 UC309	4.9 4.9	48.9	29.5	13.3	-	-	-	-	-	-	UCP309C	UCP309CD	74	2 29/32	3.7	-	-			
	2 1/2	9 1/2	2 7/8	6 23/32	25/32	1 13/32	7/8	4 31/32	3	2.189	0.874	5/8	UCP210-30 UCP210-31 UCP210 UCP210-32	P210	UC210-30 UC210-31 UC210 UC210-32	2.9 2.9 2.9 2.9	35.1	23.3	14.4	-	-	-	-	-	-	-	-	-	-	-					
50 1 7/8 1 15/16 2 1 15/16 2	2 1/2	9 1/2	2 7/8	6 23/32	25/32	1 13/32	7/8	4 31/32	3	2.189	0.874	5/8	UCPX10-31 UCPX10 UCPX10-32	PX10	UCX10-31 UCX10 UCX10-32	4.6 4.6 4.6	43.4	29.4	14.4	UCPX10C	UCPX10CD	76	3	4.6	-	-	-	-	-	-	-	-	-	-	
	2 61/64	10 13/16	2 15/16	8 11/32	25/32	1 3/8	15/16	5 13/16	3 15/32	2.402	0.866	5/8	UCP310	P310	UC310	6.6	62.0	38.3	13.2	-	-	-	-	-	-	UCP310C	UCP310CD	110	4 11/32	8.2	-	-			
	2 1/8	8 5/8	2 3/8	6 23/32	25/32	7/8	29/32	4 29/32	2 9/16	2.189	0.874	5/8	UCP211-32 UCP211-34 UCP211 UCP211-35	P211	UC211-32 UC211-34 UC211 UC211-35	3.6 3.6 3.6 3.6	43.4	29.4	14.4	-	-	-	-	-	-	-	-	-	-	-					
55 2 3/16 2 1/4 2 3/4	2 3/4	10 1/4	3 1/8	7 1/4	31/32	1 13/32	1 3/32	5 15/32	3 9/32	2.563	1.000	3/4	UCPX11 UCPX11-35 UCPX11-36	PX11	UCX11 UCX11-35 UCX11-36	6.5 6.5 6.5	52.4	36.2	14.4	UCPX11C	UCPX11CD	89	3 1/2	6.5	-	-	-	-	-	-	-	-	-	-	
	3 5/32	12 7/32	3 5/32	9 9/32	25/32	1 1/2	1 1/16	6 7/32	3 17/32	2.598	0.984	5/8	UCP311-32 UCP311 UCP311-35	P311	UC311-32 UC311 UC311-35	7.9 7.9 7.9	71.6	45.0	13.2	-	-	-	-	-	-	UCP311C	UCP311CD	114	4 1/2	9.7	-	-			
	2 1/4	9 1/2	2 3/4	7 1/4	25/32	31/32	31/32	5 7/16	2 7/8	2.563	1.000	5/8	UCP212-36 UCP212 UCP212-38 UCP212-39	P212	UC212-36 UC212 UC212-38 UC212-39	4.9 4.9 4.9 4.9	52.4	36.2	14.4	UCP212C	UCP212CD	89	3 1/2	4.9	-	-	-	-	-	UCP212FC	UCP212FCD	114	4 1/2	6.4	-
60 2 7/16 2 3/4	3	11 1/4	3 1/4	8	31/32	1 9/16	1 3/32	5 31/32	3 15/32	2.563	1.000	3/4	UCPX12 UCPX12-39	PX12	UCX12 UCX12-39	7.7 7.7	57.2	40.1	14.4	UCPX12C	UCPX12CD	89	3 1/2	7.7	-	-	-	-	-	-	-	-	-	-	
	3 11/32	13	3 11/32	9 27/32	31/32	1 1/2	1 5/32	6 9/16	4 1/16	2.795	1.024	3/4	UCP312 UCP312-39	P312	UC312 UC312-39	9.5 9.5	81.9	52.2	13.2	-	-	-	-	-	-	UCP312C	UCP312CD	124	4 7/8	11.8	-	-			
	2 1/2	10 7/16	2 3/4	8	31/32	1 3/16	1 1/16	5 29/32	3 1/16	2.563	1.000	3/4	UCP213-40 UCP213	P213	UC213-40 UC213	5.9 5.9	57.2	40.1	14.4	-	-	-	-	-	-	-	-	-	-	-					
65 2 1/2 2 1/2	3	11 1/4	3 1/4	8	31/32	1 9/16	1 3/32	6 3/32	3 15/32	2.937	1.189	3/4	UCPX13-40 UCPX13	PX13	UCX13-40 UCX13	8.1 8.1	62.2	44.1	14.5	-	-	-	-	-	-	-	-	-	-	-					
	3 35/64	13 3/8	3 17/32	10 1/4	31/32	1 1/2	1 1/4	6 15/16	4 11/32	2.953	1.181	3/4	UCP313-40 UCP313	P313	UC313-40 UC313	10.7 10.7	92.7	59.9	13.2	-	-	-	-	-	-	-	-	-	-	-					
	2 3/4	10 15/32	2 27/32	8 9/32	31/32	1 3/16	1 1/16	6 3/16	2 15/16	2.937	1.189	3/4	UCP214-44 UCP214	P214	UC214-44 UC214	6.8 6.8	62.2	44.1	14.5	-	-	-	-	-	-	UCP214C	UCP214CD	99	3 29/32	6.8	-	-			
70 2 3/4 2 3/4	3 1/2	13	3 1/2	9	1 1/16	1 31/32	1 1/4	6 3/32	3 27/32	3.063	1.331	7/8	UCPX14-44 UCPX14	PX14	UCX14-44 UCX14	10.2 10.2	67.4	48.3	14.5	-	-	-	-	-	-	-	-	-	-	-					
	3 47/64	14 3/16	3 17/32	11 1/32	1 1/16	1 9/16	1 3/8	7 5/16	4 11/32	3.071	1.299	7/8	UCP314-44 UCP314	P314	UC314-44 UC314	12.4 12.4	104	68.2	13.2	-	-	-	-	-	-	UCP314C	UCP314CD	124	4 7/8	14.7	-	-			
75 2 15/16 3	3 1/4	10 13/16	2 29/32	8 17/32	31/32	1 3/16	1 3/32	6 3/8	3 1/16	3.063	1.311	3/4	UCP215-47 UCP215 UCP215-48	P215	UC215-47 UC215 UC215-48	7.4 7.4 7.4	67.4	48.3	14.5	-	-	-	-	-	-	UCP215C	UCP215CD	99	3 29/32	7.4	-	-			

Observaciones 1. En los códigos de las unidades y de las unidades con tapas, los códigos de los accesorios siguen los números del diámetro interno.
2. Los códigos de los engrasadores apropiados para cada caso están indicados abajo.
A-1/4-28UNF 201~210, X05~X09, 305~308
A-R1/8..... 211~218, X10~X20, 309~328

3. Para los artículos con triple sellado (los que van de 201 a 205 tienen doble sellado), el código complementario L3 (o L2) sigue el código de la unidad o del rodamiento. (Ejemplo de código: UCP206JL3, UC206L3)
4. Para las medidas y las formas de los rodamientos apropiados, ver las tablas dimensionales de las combinaciones entre rodamientos de bolas y soportes.
5. Están indicados ejemplos representativos de las tipologías de soportes.
6. También están disponibles soportes de hierro fundido de estructura nodular.



UCF
Agujero cilíndrico (con tornillos prisioneros)
 d 12 ~ (45) mm

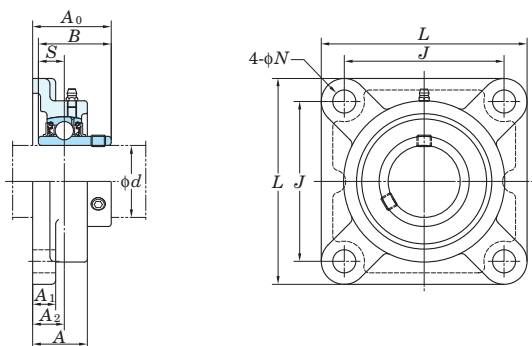

Con tapa de chapa de acero

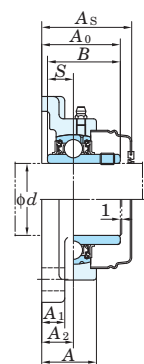

Con tapa de fundición gris

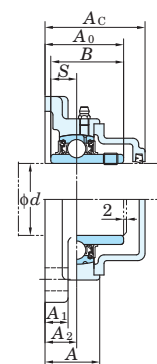

Variaciones en la tolerancia de la distancia entre la base de montaje y el centro del diámetro interno esférico (ΔA_{2s}) y en la tolerancia de la posición del agujero del tornillo (X)
 Unidad: mm

Código del Soporte	ΔA_{2s}	X
F204~F210	± 0.5	0.7
F211~F218	± 0.8	1

Variaciones en la tolerancia del diámetro del agujero del tornillo (ΔN_s)
 Unidad: mm

Código del Soporte	ΔN_s
F204~F218	± 0.2
FX20	± 0.3

Diámetro del eje mm inch d	Medidas										Tamaño del tornillo inch mm	Código Unidad.	Estándar Código Soporte.	Código Rodamiento	Peso kg	Coeficientes Básicos de Carga kN		Factor f_0	Con tapa de chapa de acero				Con tapa de fundición gris									
	L	A	J	N	A ₁	A ₂	A ₀	B	S	C _r						C _{0r}	Código Unidad		Medidas mm inch		Peso kg	Código Unidad		Medidas mm inch		Peso kg						
12 1/2	86	25.5	64	12	11	15	33.3	31	12.7	M10	UCF201	F204	UC201	0.64	12.8	6.65	13.2	UCF201C	UCF201D	37.5	1 15/32	0.64	UCF201FC	UCF201FD	46	1 13/16	0.74					
											UCF201-8		UC201-8					UCF202	UC202	UCF202-10	UC202-10		UCF203	UC203	UCF204-12	UC204-12		UCF204	UC204			
											UCF202C		UCF202D					37.5	1 15/32	0.62	UCF203C		UCF203D	37.5	1 15/32	0.61		UCF204C	UCF204D	37.5	1 15/32	0.59
											UCF202-10		UC202-10					UCF203	UC203	UCF204-12	UC204-12		UCF204	UC204								
15 5/8	86	25.5	64	12	11	15	33.3	31	12.7	M10	UCF205-14	F205	UC205-14	0.83	14.0	7.85	13.9	UCF205C	UCF205D	40.5	1 19/32	0.83	UCF205FC	UCF205FD	49	1 15/16	1.0					
											UCF205-15		UC205-15					UCF205	UC205	UCF205-16	UC205-16		UCFX05	UCX05	UCFX05-16	UCX05-16						
											UCF205C		UCF205D					40.5	1 19/32	0.83	UCF205FC		UCF205FD	49	1 15/16	1.0						
											UCF205-16		UC205-16					UCFX05	UCX05	UCFX05-16	UCX05-16											
17 3/4	86	25.5	64	12	11	15	33.3	31	12.7	M10	UCF305	F305	UC305	1.3	21.2	10.9	12.6	UCF305C	UCF305D	54	2 1/8	1.6	UCF305FC	UCF305FD	54	2 1/8	1.6					
											UCF305-16		UC305-16					UCFX06	UCX06	UCFX06-19	UCX06-19											
											UCF305C		UCF305D					54	2 1/8	1.6	UCF306C		UCF306D	59	2 5/16	2.2						
											UCF305-16		UC305-16					UCFX06	UCX06	UCFX06-19	UCX06-19											
20 3/4	86	25.5	64	12	11	15	33.3	31	12.7	M10	UCF206-18	F206	UC206-18	1.1	19.5	11.3	13.9	UCF206C	UCF206D	44.5	1 3/4	1.1	UCF206FC	UCF206FD	53	2 3/32	1.4					
											UCF206		UC206					UCF206-19	UC206-19	UCF206-20	UC206-20											
											UCF206C		UCF206D					44.5	1 3/4	1.1	UCF206FC		UCF206FD	53	2 3/32	1.4						
											UCF206-19		UC206-19					UCF206-20	UC206-20													
25 1	95	27	70	12	13	16	35.8	34.1	14.3	M10	UCF207-20	F207	UC207-20	1.5	25.7	15.4	13.9	UCF207C	UCF207D	49	1 15/16	1.5	UCF207FC	UCF207FD	58	2 9/32	1.9					
											UCF207-21		UC207-21					UCF207-22	UC207-22	UCF207	UC207		UCF207-23	UC207-23								
											UCF207C		UCF207D					49	1 15/16	1.5	UCF207FC		UCF207FD	58	2 9/32	1.9						
											UCF207-22		UCX07-22					UCFX07	UCX07	UCFX07-23	UCX07-23											
30 1 1/4	117	34	92	16	14	19	44.4	42.9	17.5	M14	UCF306	F306	UC306	1.9	26.7	15.0	13.3	UCF306C	UCF306D	59	2 5/16	2.2	UCF306FC	UCF306FD	59	2 5/16	2.2					
											UCF306		UC306																			
											UCF306C		UCF306D					59	2 5/16	2.2												
											UCF306-18		UC206-18					UCF206	UC206	UCF206-19	UC206-19		UCF206-20	UC206-20								
35 1 1/4	117	34	92	14	15	19	44.4	42.9	17.5	M12	UCF207-20	F207	UC207-20	1.5	25.7	15.4	13.9	UCF207C	UCF207D	49	1 15/16	1.5	UCF207FC	UCF207FD	58	2 9/32	1.9					
											UCF207-21		UC207-21					UCF207-22	UC207-22	UCF207	UC207		UCF207-23	UC207-23								
											UCF207C		UCF207D					49	1 15/16	1.5	UCF207FC		UCF207FD	58	2 9/32	1.9						
											UCF207-22		UCX07-22					UCFX07	UCX07	UCFX07-23	UCX07-23											
40 1 1/2	130	36	102	16	15	21	51.2	49.2	19	M14	UCF208-24	F208	UC208-24	1.9	29.1	17.8	14.0	UCF208C	UCF208D	55.5	2 3/16	1.9	UCF208FC	UCF208FD	64	2 17/32	2.3					
											UCF208-25		UC208-25					UCF208	UC208													
											UCF208C		UCF208D					55.5	2 3/16	1.9	UCF208FC		UCF208FD	64	2 17/32	2.3						
											UCF208-24		UCX08-24					UCFX08	UCX08													
45 1 1/2	137	40	105	19	14	22	52.2	49.2	19	M16	UCF308-24	F308	UC308-24	3.1	40.7	24.0	13.2	UCF308C	UCF308D	71	2 25/32	3.6	UCF308FC	UCF308FD	71	2 25/32	3.6					
											UCF308		UC308																			
											UCF308C		UCF308D					71	2 25/32	3.6												
											UCF308-24		UC308-24					UCF308	UC308													
45 1 3/4	137	38	105	16	16	22	52.2	49.2	19	M14	UCF209-26	F209	UC209-26	2.2	34.1	21.3	14.0	UCF209C	UCF209D	56.5	2 7/32	2.2	UCF209FC	UCF209FD	66	2 19/32	2.6					
											UCF209-27		UC209-27					UCF209-28	UC209-28													
											UCF209C		UCF209D					56.5	2 7/32	2.2												
											UCF209-26		UC209-26					UCF209-27	UC209-27	UCF209-28	UC209-28											

Observaciones 1. En los códigos de las unidades y de las unidades con tapas, los códigos de los accesorios siguen los números del diámetro interno.

2. Los códigos de los engrasadores apropiados para cada caso están indicados abajo.
 A-1/4-28UNF 201~210, X05~X09, 305~308
 A-R1/8..... 211~218, X10~X20, 309~328

3. Para los artículos con triple sellado (los que van de 201 a 205 tienen doble sellado), el código complementario L3 (o L2) sigue el código de la unidad o del rodamiento. (Ejemplo de código: UCF206L3, UC206L3)
 4. Para las medidas y las formas de los rodamientos apropiados, ver las tablas dimensionales de las combinaciones entre rodamientos de bolas y soportes.
 5. También están disponibles soportes de hierro fundido de estructura nodular.



UCF
Agujero cilíndrico (con tornillos prisioneros)
d (75) ~ 140 mm

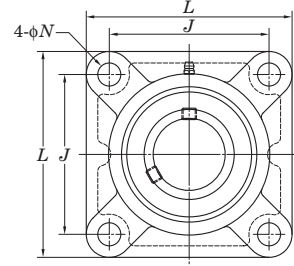
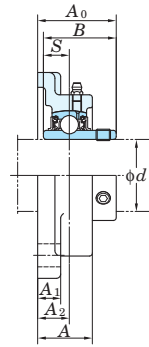

Con tapa de chapa de acero

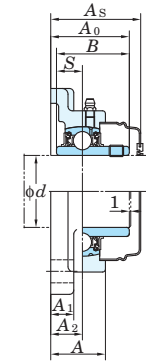

Con tapa de fundición gris

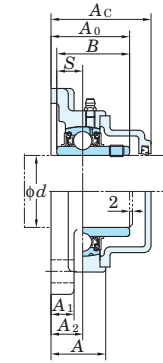

Variaciones en la tolerancia de la distancia entre la base de montaje y el centro del diámetro interno esférico (ΔA_{2s}) y en la tolerancia de la posición del agujero del tornillo (X)

Código del Soporte	ΔA_{2s}	X
F204~F210	±0.5	0.7
F211~F218	±0.8	1
FX05~FX10		
F305~F310		
F311~F328		

Unidad: mm

Variaciones en la tolerancia del diámetro del agujero del tornillo (ΔN_s)

Código del Soporte	ΔN_s
F204~F218	±0.2
FX20	±0.3
FX05~FX18	
F305~F315	
F316~F328	

Unidad: mm

Diámetro del eje mm inch d	Medidas inch mm										Tamaño del tornillo inch mm	Código Unidad.	Estándar Código Soporte.	Código Rodamiento	Peso kg	Coeficientes Básicos de Carga kN Cr Cor	Factor f0	Con tapa de chapa de acero				Con tapa de fundición gris			
	L	A	J	N	A1	A2	A0	B	S	Código Unidad								Medidas mm inch As	Peso kg	Código Unidad		Medidas mm inch Ae	Peso kg		
										Mod. abierto										Mod. cerrado por un lado	Mod. abierto			Mod. cerrado por un lado	
75 2 15/16 3	7 3/4	2 11/16	5 63/64	29/32	15/16	1 9/16	3 17/32	3.252	1.311																
	197	68	152	23	24	40	89.3	82.6	33.3	M20	UCFX15-47	FX15	UCX15-47												
												UCFX15	UCFX15D	94.5	3 23/32	8.4									
75 2 15/16 3	9 9/32	2 19/32	7 1/4	63/64	31/32	1 17/32	3 1/2	3.228	1.260																
	236	66	184	25	25	39	89	82	32	M22	UCF315-47	F315	UC315-47												
												UCF315	UCF315D	106	4 3/16	12.9									
80 3 1/8	8 3/16	2 9/32	6 1/2	29/32	7/8	1 11/32	3 9/32	3.252	1.311																
	208	58	165	23	22	34	83.3	82.6	33.3	M20	UCF216-50	F216	UC216-50												
												UCF216	UCF216D	88.5	3 15/32	7.3									
80	8 7/16	2 3/4	6 47/64	29/32	15/16	1 9/16	3 19/32	3.374	1.343																
	214	70	171	23	24	40	91.6	85.7	34.1	M20	UCFX16	FX16	UCX16												
												UCFX16	UCFX16D	96.5	3 13/16	9.4									
80	9 27/32	2 11/16	7 23/32	1 7/32	1 1/16	1 1/2	3 17/32	3.386	1.339																
	250	68	196	31	27	38	90	86	34	M27	UCF316	F316	UC316												
												UCF316	UCF316D	107	4 7/32	14.2									
85 3 1/4	8 21/32	2 15/32	6 57/64	29/32	15/16	1 13/32	3 7/16	3.374	1.343																
	220	63	175	23	24	36	87.6	85.7	34.1	M20	UCF217-52	F217	UC217-52												
												UCF217	UCF217D	92.5	3 21/32	8.9									
85	8 7/16	2 3/4	6 47/64	29/32	15/16	1 9/16	3 25/32	3.780	1.563																
	214	70	171	23	24	40	96.3	96	39.7	M20	UCFX17	FX17	UCX17												
												UCFX17-55	UCX17-55	101.5	4	10.8									
85	10 1/4	2 29/32	8 1/32	1 7/32	1 1/16	1 47/64	3 15/16	3.780	1.575																
	260	74	204	31	27	44	100	96	40	M27	UCF317	F317	UC317												
												UCF317	UCF317D	117	4 19/32	16.9									
90 3 1/2	9 1/4	2 11/16	7 23/64	29/32	31/32	1 9/16	3 25/32	3.780	1.563																
	235	68	187	23	25	40	96.3	96	39.7	M20	UCF218-56	F218	UC218-56												
												UCF218	UCF218D	101.5	4	11.4									
90	8 7/16	3	6 47/64	29/32	15/16	1 49/64	4 3/16	4.094	1.689																
	214	76	171	23	24	45	106.1	104	42.9	M20	UCFX18	FX18	UCX18												
												UCFX18	UCFX18C	124	4 7/8	13.6									
90	11 1/32	3	8 1/2	1 3/8	1 3/16	1 47/64	3 15/16	3.780	1.575																
	280	76	216	35	30	44	100	96	40	M30	UCF318-56	F318	UC318-56												
												UCF318	UCF318D	119	4 11/16	20.8									
95	11 13/32	3 11/16	8 31/32	1 3/8	1 3/16	2 21/64	4 3/4	4.055	1.614																
	290	94	228	35	30	59	121	103	41	M30	UCF319	F319	UC319												
												UCF319	UCF319D	140	5 1/2	23.8									
100 3 15/16 4	10 9/16	3 13/16	8 5/16	1 7/32	1 3/32	2 21/64	5	4.626	1.937																
	268	97	211	31	28	59	127.3	117.5	49.2	M27	UCFX20	FX20	UCX20												
												UCFX20-63	UCX20-63	152	5 31/32	21.6									
100	12 7/32	3 11/16	9 17/32	1 1/2	1 1/4	2 21/64	4 29/32	4.252	1.654																
	310	94	242	38	32	59	125	108	42	M33	UCF320	F320	UC320												
												UCF320-63	UC320-63	146	5 3/4	28.6									
105	12 7/32	3 11/16	9 17/32	1 1/2	1 1/4	2 21/64	5	4.409	1.732																
	310	94	242	38	32	59	127	112	44	M33	UCF321	F321	UC321												
												UCF321	UCF321D	148	5 13/16	33.2									
110	13 3/8	3 25/32	10 15/32	1 39/64	1 3/8	2 23/64	5 5/32	4.606	1.811																
	340	96	266	41	35	60	131	117	46	M36	UCF322	F322	UC322												
												UCF322	UCF322D	154	6 1/16	41.7									
120	14 9/16	4 11/32	11 27/64	1 39/64	1 9/16	2 9/16	5 1/2	4.961	2.008																
	370	110	290	41	40	65	140	126	51	M36	UCF324	F324	UC324												
												UCF324	UCF324D	163	6 13/32	52.1									
130	16 5/32	4 17/32	12 19/32	1 39/64	1 25/32	2 9/16	5 3/4	5.315	2.126																
	410	115	320	41	45	65	146	135	54	M36	UCF326	F326	UC326												
												UCF326	UCF326D	172	6 25/32	71.6									
140	17 23/32	4 29/32	13 25/32	1 39/64	2 5/32	2 61/64	6 11/32	5.709	2.323																
	450	125	350	41	55	75	161	145	59	M36	UCF328	F328	UC328												
												UCF328	UCF328D	186	7 5/16	89									

Observaciones: 1. En los códigos de las unidades y de las unidades con tapas, los códigos de los accesorios siguen los números del diámetro interno.
 2. Los códigos de los engrasadores apropiados para cada caso están indicados abajo:
 A-1/4-28UNF 201~210, X05~X09, 305~308
 A-R1/8..... 211~218, X10~X20, 309~328
 3. Para los artículos con triple sellado (los que van de 201 a 205 tienen doble sellado), el código complementario L3 (o L2) sigue el código de la unidad o del rodamiento. (Ejemplo de código: UCF206JL3, UC206L3)
 4. Para las medidas y las formas de los rodamientos apropiados, ver las tablas dimensionales de las combinaciones entre rodamientos de bolas y soportes.
 5. También están disponibles soportes de hierro fundido de estructura nodular.



UCFL
Agujero cilíndrico (con tornillos prisioneros)
d 12 ~ (45) mm

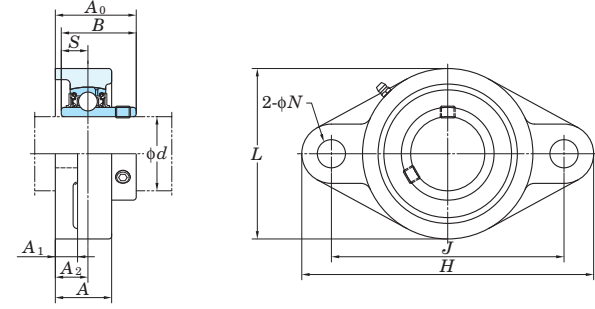

Con tapa de chapa de acero Con tapa de fundición gris

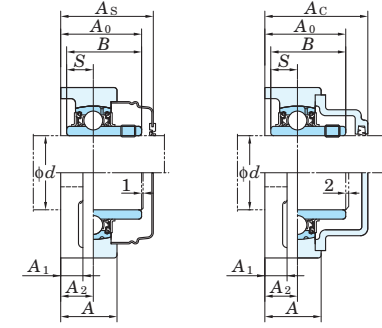

Variaciones en la tolerancia de la distancia entre la base de montaje y el centro del diámetro interno esférico (ΔA2s) y en la tolerancia de la posición del agujero del tornillo (X)
Unidad: mm

Código del Soporte	ΔA2s	X
FL204~FL210	±0.5	0.7
FL211~FL218	±0.8	1

Variaciones en la tolerancia del diámetro del agujero del tornillo (ΔNs)
Unidad: mm

Código del Soporte	ΔNs
FL204~FL218	±0.2
FL311~FL312	±0.3
FL312~FL324	±0.3

Las formas y las medidas de Lc para FL204JE3 y FL205JE3 (soporte con tapa de fundición gris) están indicadas abajo.

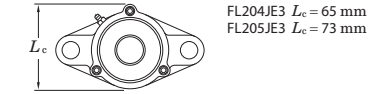

Diámetro del eje mm inch d	Medidas										Tamaño del tornillo inch mm	Estándar			Peso kg	Coeficientes Básicos de Carga kN		Factor f0	Con tapa de chapa de acero				Con tapa de fundición gris																													
	mm											Código Unidad	Código Soporte	Código Rodamiento		Cr	Cor		Código Unidad		Medidas		Peso kg	Código Unidad		Medidas																										
	H	L	A	J	N	A1	A2	A0	B	S									Mod. abierto	Mod. cerrado por un lado	mm	inch		Mod. abierto	Mod. cerrado por un lado	mm	inch	Peso kg																								
12	1/2																	UCFL201C	UCFL201D	37.5	1 15/32	0.50	—	—	—	—																										
15	5/8	4 7/16	2 3/8	1	3 35/64	15/32	7/16	19/32	1 5/16	1.220	0.500	3/8	UCFL201-8	FL204	UC201-8	0.50		—	—	—	—	—	—	—	—	—	—	—	—	—																						
17	3/4	113	60	25.5	90	12	11	15	33.3	31	12.7	M10	UCFL202-10		UC202	0.48	12.8	6.65	13.2	UCFL202C	UCFL202D	37.5	1 15/32	0.48	—	—	—	—	—	—	—																					
20													UCFL203		UC203	0.47				UCFL203C	UCFL203D	37.5	1 15/32	0.47	—	—	—	—	—	—	—																					
													UCFL204-12		UC204-12	0.47				—	—	—	—	—	—	—	—	—	—	—	—																					
													UCFL204		UC204	0.45				UCFL204C	UCFL204D	37.5	1 15/32	0.45	UCFL204FC	UCFL204FD	46	1 13/16	0.6	—	—																					
													UCFL205-14		UC205-14	0.64				—	—	—	—	—	—	—	—	—	—	—	—	—	—																			
													UCFL205-15		UC205-15	0.64				—	—	—	—	—	—	—	—	—	—	—	—	—	—	—	—																	
													UCFL205		UC205	0.64				UCFL205C	UCFL205D	40.5	1 19/32	0.64	UCFL205FC	UCFL205FD	49	1 15/16	0.83	—	—																					
													UCFL205-16		UC205-16	0.64				—	—	—	—	—	—	—	—	—	—	—	—	—	—	—	—																	
													UCFLX05	FLX05	UCX05	1.1	19.5	11.3	13.9	UCFLX05C	UCFLX05D	44.5	1 3/4	1.1	—	—	—	—	—	—	—	—	—	—	—	—	—															
													UCFLX05-16		UCX05-16	1.1				—	—	—	—	—	—	—	—	—	—	—	—	—	—	—	—																	
													UCFL305	FL305	UC305	1.1	21.2	10.9	12.6	—	—	—	—	—	UCFL305C	UCFL305D	54	2 1/8	1.4	—	—																					
													UCFL305-16		UC305-16	1.1				—	—	—	—	—	—	—	—	—	—	—	—	—	—	—	—	—																
													UCFL206-18		UC206-18	0.93				—	—	—	—	—	—	—	—	—	—	—	—	—	—	—	—	—																
													UCFL206	FL206	UC206	0.93	19.5	11.3	13.9	UCFL206C	UCFL206D	44.5	1 3/4	0.93	UCFL206FC	UCFL206FD	53	2 3/32	1.2	—	—																					
													UCFL206-19		UC206-19	0.93				—	—	—	—	—	—	—	—	—	—	—	—	—	—	—	—	—	—															
													UCFL206-20		UC206-20	0.93				—	—	—	—	—	—	—	—	—	—	—	—	—	—	—	—	—	—	—														
													UCFLX06	FLX06	UCX06	1.5	25.7	15.4	13.9	UCFLX06C	UCFLX06D	49	1 15/16	1.5	—	—	—	—	—	—	—	—	—	—	—	—	—	—	—	—	—											
													UCFLX06-19		UCX06-19	1.5				—	—	—	—	—	—	—	—	—	—	—	—	—	—	—	—	—	—	—	—													
													UCFLX06-20		UCX06-20	1.5				—	—	—	—	—	—	—	—	—	—	—	—	—	—	—	—	—	—	—	—													
													UCFL306	FL306	UC306	1.5	26.7	15.0	13.3	—	—	—	—	—	UCFL306C	UCFL306D	59	2 5/16	1.8	—	—																					
													UCFL207-20		UC207-20	1.2				—	—	—	—	—	—	—	—	—	—	—	—	—	—	—	—	—	—	—	—	—												
													UCFL207-21		UC207-21	1.2				—	—	—	—	—	—	—	—	—	—	—	—	—	—	—	—	—	—	—	—	—	—											
													UCFL207-22	FL207	UC207-22	1.2	25.7	15.4	13.9	—	—	—	—	—	—	—	—	—	—	—	—	—	—	—	—	—	—	—	—	—	—	—										
													UCFL207		UC207	1.2				UCFL207C	UCFL207D	49	1 15/16	1.2	UCFL207FC	UCFL207FD	58	2 9/32	1.6	—	—																					
													UCFL207-23		UC207-23	1.2				—	—	—	—	—	—	—	—	—	—	—	—	—	—	—	—	—	—	—	—	—	—											
													UCFLX07-22		UCX07-22	1.9				—	—	—	—	—	—	—	—	—	—	—	—	—	—	—	—	—	—	—	—	—	—											
													UCFLX07	FLX07	UCX07	1.9	29.1	17.8	14.0	UCFLX07C	UCFLX07D	55.5	2 3/16	1.9	—	—	—	—	—	—	—	—	—	—	—	—	—	—	—	—	—	—	—	—								
													UCFLX07-23		UCX07-23	1.9				—	—	—	—	—	—	—	—	—	—	—	—	—	—	—	—	—	—	—	—	—	—	—										
													UCFL307	FL307	UC307	1.8	33.4	19.3	13.2	—	—	—	—	—	UCFL307C	UCFL307D	64	2 17/32	2.2	—	—																					
													UCFL208-24		UC208-24	1.6				—	—	—	—	—	—	—	—	—	—	—	—	—	—	—	—	—	—	—	—	—	—	—	—									
													UCFL208-25		UC208-25	1.6	29.1	17.8	14.0	—	—	—	—	—	—	—	—	—	—	—	—	—	—	—	—	—	—	—	—	—	—	—	—	—	—							
													UCFL208	FL208	UC208	1.6				UCFL208C	UCFL208D	55.5	2 3/16	1.6	UCFL208FC	UCFL208FD	64	2 17/32	2.0	—	—																					
													UCFLX08-24	FLX08	UCX08-24	2.1	34.1	21.3	14.0	—	—	—	—	—	—	—	—	—	—	—	—	—	—	—	—	—	—	—	—	—	—	—	—	—	—							
													UCFLX08		UCX08	2.1				UCFLX08C	UCFLX08D	56.5	2 7/32	2.1	—	—	—	—	—	—	—	—	—	—	—	—	—	—	—	—	—	—	—	—	—	—						
													UCFL308-24	FL308	UC308-24	2.5	40.7	24.0	13.2	—	—	—	—	—	—	—	—	—	—	—	—	—	—	—	—	—	—	—	—	—	—	—	—	—	—	—	—					
													UCFL308		UC308	2.5				—	—	—	—	—	—	—	—	—	—	—	—	—	—	—	—	—	—	—	—	—	—	—	—	—	—	—						
													UCFL209-26		UC209-26	1.9				—	—	—	—	—	—	—	—	—	—	—	—	—	—	—	—	—	—	—	—	—	—	—	—	—	—	—	—					
													UCFL209-27		UC209-27	1.9				—	—	—	—	—	—	—	—	—	—	—	—	—	—	—	—	—	—	—	—	—	—	—	—	—	—	—	—	—				
													UCFL209-28		UC209-28	1.9				—	—	—	—	—	—	—	—	—	—	—	—	—	—	—	—	—	—	—	—	—	—	—	—	—	—	—	—	—				
													UCFL209	FL209	UC209	1.9	34.1	21.3	14.0	UCFL209C	UCFL209D	56.5	2 7/32	1.9	UCFL209FC	UCFL209FD	66	2 19/32	2.3	—	—																					

Observaciones 1. En los códigos de las unidades y de las unidades con tapas, los códigos de los accesorios siguen los números del diámetro interno.
2. Los códigos de los engrasadores apropiados para cada caso están indicados abajo.
A-1/4-28UNF 201~210, X05~X09, 305~308
A-R1

UCFL

Agujero cilíndrico (con tornillos prisioneros)
d (45) ~ (85) mm

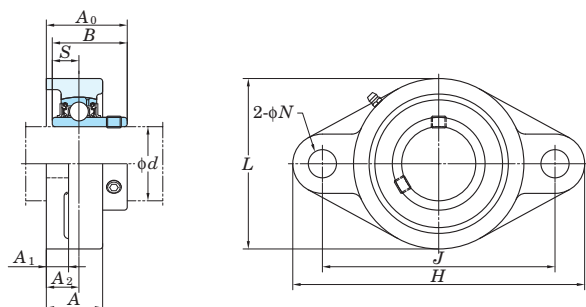

Con tapa de chapa de acero Con tapa de fundición gris

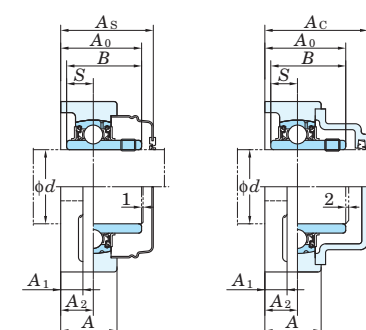

Variaciones en la tolerancia de la distancia entre la base de montaje y el centro del diámetro interno esférico (ΔA_{2s}) y en la tolerancia de la posición del agujero del tornillo (X)
Unidad: mm

Código del Soporte	ΔA_{2s}	X		
FL204~FL210	FLX05~FLX10	FL305~FL310	±0.5	0.7
FL211~FL218		FL311~FL324	±0.8	1

Variaciones en la tolerancia del diámetro del agujero del tornillo (ΔA_s)
Unidad: mm

Código del Soporte	ΔA_s		
FL204~FL218	FLX05~FLX10	FL305~FL311	±0.2
		FL312~FL324	±0.3

Las formas y las medidas de L_c para FL204JE3 y FL205JE3 (soporte con tapa de fundición gris) están indicadas abajo.



Diámetro del eje mm inch d	Medidas inch mm										Tamaño del tornillo inch mm	Estándar			Peso kg	Coeficientes Básicos de Carga kN			Factor f_0	Con tapa de chapa de acero				Con tapa de fundición gris				
	H	L	A	J	N	A_1	A_2	A_0	B	S		Código Unidad	Código Soporte	Código Rodamiento		C_r	C_{0r}	Código Unidad		Medidas mm inch	Peso kg	Código Unidad		Medidas mm inch	Peso kg			
																		Mod. abierto				Mod. cerrado por un lado	Mod. abierto			Mod. cerrado por un lado		
45	$1^{11}/16$	$7^{7}/16$	$4^{9}/16$	$1^{9}/16$	$6^{3}/16$	5/8	9/16	$2^{9}/32$	$2^{3}/16$	2.031	0.748	1/2																
	$1^{3}/4$																											
		189	116	40	157	16	14	23	55.6	51.6	19																	
45	$1^{3}/4$	$9^{1}/16$	$4^{29}/32$	$1^{23}/32$	$6^{31}/32$	$6^{3}/64$	$2^{3}/32$	$6^{3}/64$	$2^{3}/8$	2.244	0.866	7/8																
		230	125	44	177	25	18	25	60	57	22																	
50	$1^{7}/8$	$7^{3}/4$	$4^{17}/32$	$1^{9}/16$	$6^{3}/16$	3/4	$1^{9}/32$	$5^{5}/64$	$2^{5}/32$	2.031	0.748	5/8																
	$1^{15}/16$																											
		197	115	40	157	19	15	22	54.6	51.6	19																	
50	2	$8^{1}/2$	$5^{1}/4$	$1^{23}/32$	$7^{1}/4$	3/4	$2^{5}/32$	$1^{1}/32$	$2^{11}/32$	2.189	0.874	5/8																
	2																											
		216	133	44	184	19	20	26	59.4	55.6	22.2																	
50	-	$9^{7}/16$	$5^{1}/2$	$1^{7}/8$	$7^{23}/64$	$6^{3}/64$	3/4	$1^{7}/64$	$2^{5}/8$	2.402	0.866	7/8																
		240	140	48	187	25	19	28	67	61	22																	
55	2	$8^{13}/16$	$5^{1}/8$	$1^{11}/16$	$7^{1}/4$	3/4	$2^{3}/32$	$6^{3}/64$	$2^{5}/16$	2.189	0.874	5/8																
	$2^{1}/8$																											
		224	130	43	184	19	18	25	58.4	55.6	22.2																	
55	$2^{3}/16$	$9^{27}/32$	$5^{29}/32$	$2^{1}/16$	$7^{51}/64$	$6^{3}/64$	$2^{5}/32$	$1^{3}/16$	$2^{25}/32$	2.598	0.984	7/8																
	2																											
		250	150	52	198	25	20	30	71	66	25																	
60	$2^{1}/4$	$9^{27}/32$	$5^{1}/2$	$1^{7}/8$	$7^{61}/64$	$2^{9}/32$	$2^{3}/32$	$1^{9}/64$	$2^{23}/32$	2.563	1.000	3/4																
	$2^{3}/8$																											
		250	140	48	202	23	18	29	68.7	65.1	25.4																	
60	$2^{7}/16$	$10^{5}/8$	$6^{5}/16$	$2^{7}/32$	$8^{11}/32$	$1^{7}/32$	7/8	$1^{19}/64$	$3^{1}/16$	2.795	1.024	1																
		270	160	56	212	31	22	33	78	71	26																	
65	$2^{1}/2$	$10^{5}/32$	$6^{3}/32$	$1^{31}/32$	$8^{17}/64$	$2^{9}/32$	$2^{5}/32$	$1^{3}/16$	$2^{3}/4$	2.563	1.000	3/4																
		258	155	50	210	23	20	30	69.7	65.1	25.4																	
65	$2^{1}/2$	$11^{5}/8$	$6^{7}/8$	$2^{9}/32$	$9^{29}/64$	$1^{7}/32$	$3^{1}/32$	$1^{19}/64$	$3^{1}/16$	2.953	1.181	1																
		295	175	58	240	31	25	33	78	75	30																	
70	$2^{3}/4$	$10^{7}/16$	$6^{5}/16$	$2^{11}/8$	$8^{17}/2$	$2^{9}/32$	$2^{5}/32$	$1^{7}/32$	$2^{31}/32$	2.937	1.189	3/4																
		265	160	54	216	23	20	31	75.4	74.6	30.2																	
70	$2^{3}/4$	$12^{13}/32$	$7^{9}/32$	$2^{13}/32$	$9^{27}/32$	$1^{3}/8$	$1^{3}/32$	$1^{27}/64$	$3^{3}/16$	3.071	1.299	1 1/8																
		315	185	61	250	35	28	36	81	78	33																	
75	$2^{15}/16$	$10^{13}/16$	$6^{1}/2$	$2^{7}/32$	$8^{55}/64$	$2^{9}/32$	$2^{5}/32$	$1^{11}/32$	$3^{3}/32$	3.063	1.311	3/4																
	3																											
		275	165	56	225	23	20	34	78.5	77.8	33.3																	
75	$2^{15}/16$	$12^{19}/32$	$7^{11}/16$	$2^{19}/32$	$10^{15}/64$	$1^{3}/8$	$1^{3}/16$	$1^{17}/32$	$3^{1}/2$	3.228	1.260	1 1/8																
		320	195	66	260	35	30	39	89	82	32																	
80	$3^{1}/8$	$11^{13}/32$	$7^{3}/32$	$2^{9}/32$	$9^{11}/64$	$6^{3}/64$	$2^{5}/32$	$1^{11}/32$	$3^{9}/32$	3.252	1.311	7/8																
		290	180	58	233	25	20	34	83.3	82.6	33.3																	
80	-	$13^{31}/32$	$8^{9}/32$	$2^{11}/16$	$11^{7}/32$	$1^{1}/2$	$1^{1}/4$	$1^{1}/2$	$3^{17}/32$	3.386	1.339	1 1/4																
		355	210	68	285	38	32	38	90	86	34																	
85	$3^{1}/4$	12	$7^{15}/32$	$2^{15}/32$	$9^{49}/64$	$6^{3}/64$	7/8	$1^{27}/64$	$3^{7}/16$	3.374	1.343	7/8																
		305	190	63	248	25	22	36	87.6	85.7	34.1																	

UCFL
Agujero cilíndrico (con tornillos prisioneros)
d (85) ~ 120 mm

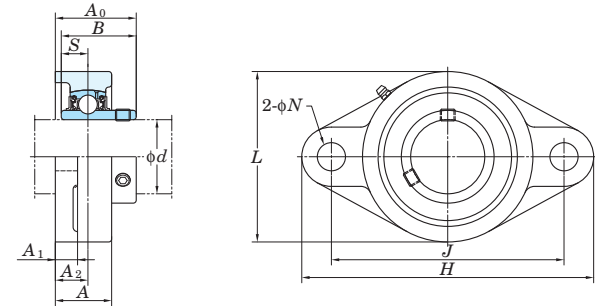

Con tapa de chapa de acero Con tapa de fundición gris

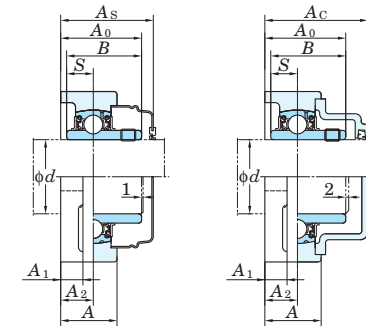

Variaciones en la tolerancia de la distancia entre la base de montaje y el centro del diámetro interno esférico (ΔA_{2a}) y en la tolerancia de la posición del agujero del tornillo (X) Unidad: mm

Código del Soporte	ΔA_{2a}	X
FL204~FL210	±0.5	0.7
FL211~FL218	±0.8	1

Variaciones en la tolerancia del diámetro del agujero del tornillo (ΔN_a) Unidad: mm

Código del Soporte	ΔN_a
FL204~FL218	±0.2
FL305~FL311	±0.2
FL312~FL324	±0.3

Las formas y las medidas de L_c para FL204JE3 y FL205JE3 (soporte con tapa de fundición gris) están indicadas abajo.

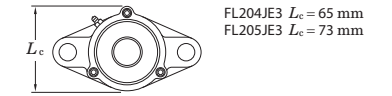

Diámetro del eje mm inch d	Medidas inch mm											Tamaño del tornillo inch mm	Estándar			Peso kg	Coeficientes Básicos de Carga kN			Factor f_0	Con tapa de chapa de acero					Con tapa de fundición gris				
	H	L	A	J	N	A ₁	A ₂	A ₀	B	S	Código Unidad		Código Soporte	Código Rodamiento	C _r		C _{0r}	Código Unidad			Medidas mm inch A _s	Peso kg	Código Unidad		Medidas mm inch A _e	Peso kg				
																		Mod. abierto	Mod. cerrado por un lado				Mod. abierto	Mod. cerrado por un lado						
85	14 9/16 370	8 21/32 220	2 29/32 74	11 13/16 300	1 1/2 38	1 1/4 32	1 47/64 44	3 15/16 100	3.780 96	1.575 40	1 1/4 M33	FL317	UC317	16.0	133	96.8	13.3	-	-	-	-	-	UCFL317C	UCFL317D	117	4 19/32 17.6	17.6			
90	3 1/2 320	12 19/32 205	8 1/16 68	2 11/16 265	1 1/2 25	1 1/4 23	1 37/64 40	3 25/32 96.3	3.780 96	1.563 39.7	1 1/4 M22	FL218	UC218-56 UC218	12.3 12.3	96.1 71.5	14.5	-	-	-	-	-	-	-	-	-	-				
																	UCFL218C	UCFL218D	101.5	4	12.3	UCFL218FC	UCFL218FD	116	4 9/16 13.8	13.8				
90	3 1/2 385	15 5/32 235	9 1/4 76	3 12 13/32 315	1 1/2 38	1 13/32 36	1 47/64 44	3 15/16 100	3.780 96	1.575 40	1 1/4 M33	FL318	UC318-56 UC318	19.0 19.0	143 107	13.3	-	-	-	-	-	-	-	-	-	-				
																	UCFL318C	UCFL318D	119	4 11/16 20.9	20.9									
95	15 15/16 405	9 27/32 250	3 11/16 94	13 1 39/64 330	1 9/16 41	1 9/16 40	2 21/64 59	4 3/4 121	4.055 103	1.614 41	1 3/8 M36	FL319	UC319	24.6	153	119	13.3	-	-	-	-	-	-	-	-	-				
																		UCFL319C	UCFL319D	140	5 1/2 26.8	26.8								
100	3 15/16 4	17 5/16 440	10 5/8 270	3 11/16 94	14 11/64 360	1 47/64 44	1 9/16 40	2 21/64 59	4 29/32 125	4.252 108	1.654 42	1 1/2 M39	FL320	UC320 UC320-63 UC320-64	29.4 29.4 29.4	173 141	13.2	-	-	-	-	-	-	-	-	-	-			
																		UCFL320C	UCFL320D	146	5 3/4 32.2	32.2								
																		-	-	-	-	-	-	-	-	-	-	-	-	-
110	18 1/2 470	11 13/16 300	3 25/32 96	15 23/64 390	1 47/64 44	1 21/32 42	2 23/64 60	5 5/32 131	4.606 117	1.811 46	1 1/2 M39	FL322	UC322	36.2	205	180	13.2	-	-	-	-	-	-	-	-	-				
																		UCFL322C	UCFL322D	154	6 1/16 39.6	39.6								
120	20 15/32 520	13 4 11/32 330	4 11/32 110	16 59/64 430	1 27/32 47	1 7/8 48	2 9/16 65	5 1/2 140	4.961 126	2.008 51	1 5/8 M42	FL324	UC324	51.6	207	185	13.5	-	-	-	-	-	-	-	-	-				
																		UCFL324C	UCFL324D	163	6 13/32 56.4	56.4								

Observaciones 1. En los códigos de las unidades y de las unidades con tapas, los códigos de los accesorios siguen los números del diámetro interno.
 2. Los códigos de los engrasadores apropiados para cada caso están indicados abajo.
 A-1/4-28UNF 201~210, X05~X09, 305~308
 A-R1/8 211~218, X10, 309~324

3. Para los artículos con triple sellado (los que van de 201 a 205 tienen doble sellado), el código complementario L3 (o L2) sigue el código de la unidad o del rodamiento. (Ejemplo de código: UCFL206JL3, UC206L3)
 4. Para las medidas y las formas de los rodamientos apropiados, ver las tablas dimensionales de las combinaciones entre rodamientos de bolas y soportes.
 5. También están disponibles soportes de hierro fundido de estructura nodular.



UCFB
Agujero cilíndrico (con tornillos prisioneros)
d 12 ~ 50 mm

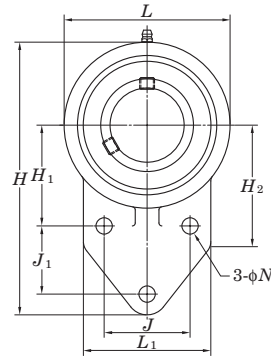
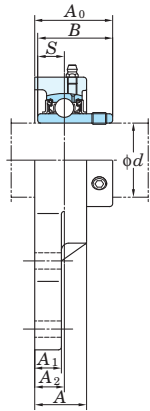

Variaciones en la tolerancia de la distancia entre la base de montaje y el centro del diámetro interno esférico (ΔA_{2s}), entre los centros de los agujeros de los tornillos ($\Delta J_s, \Delta J_{1s}$) y entre ambas ranuras (ΔH_{1s})

Código del Soporte	ΔA_{2s}	ΔJ_s	ΔJ_{1s}	ΔH_{1s}
FB204~FB210	±0.5			

Variaciones en la tolerancia del diámetro del agujero del tornillo (ΔN_s)

Código del Soporte	ΔN_s
FB204~FB210	±0.2

Diámetro del eje mm inch d	Medidas inch mm														Tamaño del tornillo inch mm	Código Unidad	Código Soporte	Código Rodamiento	Coeficientes Básicos de Carga kN		Factor f_0	Peso kg			
	H	L	A	J	J ₁	N	H ₁	H ₂	L ₁	A ₁	A ₂	A ₀	B	S					C _r	C _{0r}					
12 1/2																	5/16	UCFB201 UCFB201-8 UCFB202 UCFB202-10 UCFB203 UCFB204-12 UCFB204	FB204	UC201 UC201-8 UC202 UC202-10 UC203 UC204-12 UC204	12.8	6.65	13.2	0.64 0.62 0.61 0.59	
15 5/8	4 11/32	2 7/16	1 5/16	1 17/64	1 1/16	3/8	1 21/32	2 1/16	2 1/16	1/2	1 17/32	1 1/4	1.220	0.500			5/16	UCFB205-14 UCFB205-15 UCFB205 UCFB205-16	FB205	UC205-14 UC205-15 UC205 UC205-16	14.0	7.85	13.9	0.68	
17 3/4	110	62	24.5	32	27	9.5	42	52	52	13	13.5	31.8	31	12.7			M8	UCFB206-18 UCFB206 UCFB206-19 UCFB206-20	FB206	UC206-18 UC206 UC206-19 UC206-20	19.5	11.3	13.9	0.92	
20																	UCFB207-20 UCFB207-21 UCFB207-22 UCFB207 UCFB207-23	FB207	UC207-20 UC207-21 UC207-22 UC207 UC207-23	25.7	15.4	13.9	1.3		
25 7/8	4 9/16	2 11/16	1 1/16	1 11/32	1 1/16	3/8	1 49/64	2 1/16	2 7/32	1/2	1 19/32	1 3/8	1.343	0.563			5/16	UCFB208-24 UCFB208-25 UCFB208 UCFB209-26 UCFB209-27 UCFB209-28 UCFB209	FB208	UC208-24 UC208-25 UC208 UC209-26 UC209-27 UC209-28 UC209	29.1	17.8	14.0	1.8	
30 1 1/8	5 1/8	3 1/16	1 3/16	1 37/64	1 9/64	3/8	1 31/32	2 5/32	2 9/16	1/2	4 3/64	1 17/32	1.500	0.626			5/16	UCFB210-30 UCFB210-31 UCFB210 UCFB210-32	FB210	UC210-30 UC210-31 UC210 UC210-32	35.1	23.3	14.4	2.3	
35 1 1/4	5 21/32	3 17/32	1 5/16	1 13/16	1 17/64	3/8	2 11/64	2 7/16	2 3/4	1 19/32	3/4	1 3/4	1.689	0.689			M8								
40 1 1/2	6 15/32	3 15/16	1 3/8	1 31/32	1 39/64	7/16	2 23/64	2 27/32	3 1/16	5/8	2 25/32	1 31/32	1.937	0.748			3/8								
45 1 5/8	6 27/32	4 3/16	1 3/8	2 1/8	1 11/16	7/16	2 9/16	3	3 3/32	2 23/32	2 25/32	1 31/32	1.937	0.748			M10								
50 1 7/8	7 1/4	4 13/32	1 7/16	2 9/32	1 13/16	7/16	2 43/64	3 7/32	3 3/8	2 23/32	2 25/32	2 1/16	2.031	0.748			M10								

Observaciones 1. En los códigos de las unidades y de las unidades con tapas, los códigos de los accesorios siguen los números del diámetro interno.
2. El código del engrasador apropiado es A-1/4-28UNF.
3. Para los artículos con triple sellado (los que van de 201 a 205 tienen doble sellado), el código complementario L3 (o L2) sigue el código de la unidad o del rodamiento. (Ejemplo de código: UCFB206JL3, UC206L3)

4. Para las medidas y las formas de los rodamientos apropiados para cada caso, ver las tablas dimensionales de las combinaciones entre rodamientos y soportes.
5. También están disponibles productos con agujero cónico (con manguito). (Ejemplo de código: UKFB205J + H2305X, UK205+H2305X)



UCFC
Agujero cilíndrico (con tornillos prisioneros)
d 12 ~ 50 mm

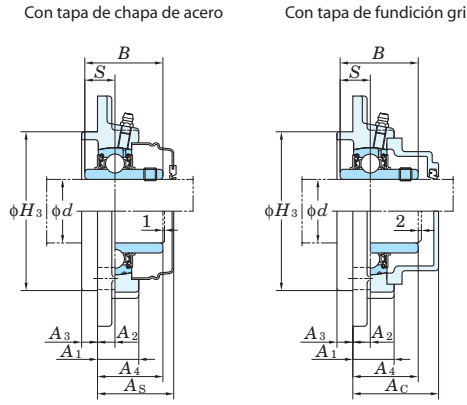
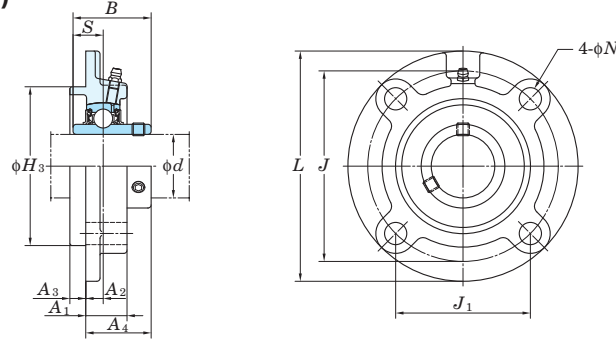

Variaciones en la tolerancia del diámetro externo del resalte de centraje (ΔH_{35}), de la distancia entre la base de montaje y el centro del diámetro interno esférico (ΔA_{25}), y de la posición del agujero del tornillo (X).

Código del Soporte		ΔH_{35}	ΔA_{25}	X	Y
FC204~FC206	FCX05	0 -0.046	±0.5	0.7	0.2
FC207~FC210	FCX06~FCX10	0 -0.054			
FC211~FC217	FCX11~FCX15	0 -0.063			
FC218	FCX16~FCX18 FCX20	0 -0.072	±0.8	1	0.3
					0.4

Unidad: mm

Variaciones en la tolerancia del diámetro del agujero del tornillo (ΔN_5)

Código del Soporte	ΔN_5
FC204~FC218 FCX05~FCX20	±0.2

Unidad: mm

Diámetro del eje mm inch d	Medidas inch mm												Tamaño del tornillo inch mm	Estandar Código Unidad	Código Soporte	Código Rodamiento	Peso kg	Coeficientes Básicos de Carga kN			Factor f ₀	Con tapa de chapa de acero				Con tapa de fundición gris																																																																																																																																																																																																																																																																																																																																																																																																																																																																																																																																																																																																																																																																																																																																																																																							
	L	H ₃	J	J ₁	N	A ₁	A ₂	A ₃	A ₄	B	S	C _r						C _{0r}	Código Unidad	Medidas mm inch		Peso kg	Código Unidad	Medidas mm inch	Peso kg																																																																																																																																																																																																																																																																																																																																																																																																																																																																																																																																																																																																																																																																																																																																																																																								
	Mod. abierto	Mod. cerrado por un lado	A ₅	Mod. abierto	Mod. cerrado por un lado	A ₆	kg	Mod. abierto	Mod. cerrado por un lado	A _e	kg																																																																																																																																																																																																																																																																																																																																																																																																																																																																																																																																																																																																																																																																																																																																																																																																						
12	1/2												UCFC201	FC204	UC201	0.78																	15	5/8	3 15/16	2.4409	3 5/16	2 11/64	15/32	13/16	25/64	13/64	1 1/8	1.220	0.500	UCFC201-8 UCFC202 UCFC202-10 UCFC203 UCFC204-12 UCFC204		UC201-8 UC202 UC202-10 UC203 UC204-12 UC204	0.78 0.76 0.76 0.75 0.75 0.73	12.8	6.65	13.2	UCFC201C UCFC201D UCFC202C UCFC202D UCFC203C UCFC203D UCFC204C UCFC204D	32.5 32.5	1 9/32	0.78 0.76										17	3/4	100	62	78	55.1	12	20.5	10	5	28.3	31	12.7																					20													UCFC205-14 UCFC205-15 UCFC205 UCFC205-16	FC205	UC205-14 UC205-15 UC205 UC205-16	0.95 0.95 0.95 0.95	14.0	7.85	13.9								UCFC204FC UCFC204FD	41	1 17/32	0.84											25	7/8	4 17/32	2.7559	3 35/64	2 1/2	15/32	13/16	25/64	15/64	1 3/16	1.343	0.563	UCFC205-14 UCFC205-15 UCFC205 UCFC205-16		UC205-14 UC205-15 UC205 UC205-16	0.95 0.95 0.95 0.95	14.0	7.85	13.9	UCFC205C UCFC205D	34.5	1 11/32	0.95			UCFC205FC UCFC205FD	43	1 21/32	1.1											1 15/16												UCFCX05 UCFCX05-16	FCX05	UCX05 UCX05-16	1.2 1.2	19.5	11.3	13.9	UCFCX05C UCFCX05D	36.5	1 7/16	1.2																		1	4 3/8	2.9921	3 5/8	2 9/16	3/8	15/16	25/64	15/64	1 9/32	1.500	0.626	UCFC206-18 UCFC206 UCFC206-19 UCFC206-20	FC206	UC206-18 UC206 UC206-19 UC206-20	1.3 1.3 1.3 1.3	19.5	11.3	13.9	UCFC206C UCFC206D	36.5	1 7/16	1.3			UCFC206FC UCFC206FD	45	1 25/32	1.6														1 1/8	4 29/32	3.1496	3 15/16	2 25/32	15/32	29/32	25/64	5/16	1 9/32	1.500	0.626	UCFCX06 UCFCX06-19 UCFCX06-20	FCX06	UCX06 UCX06-19 UCX06-20	1.5 1.5 1.5	25.7	15.4	13.9	UCFCX06C UCFCX06D	38	1 1/2	1.5																						1 3/16	5	3.3465	4 9/64	2 59/64	15/32	7/8	5/16	3/8	1 5/16	1.689	0.689	UCFC207-20 UCFC207-21 UCFC207-22 UCFC207 UCFC207-23	FC207	UC207-20 UC207-21 UC207-22 UC207 UC207-23	1.7 1.7 1.7 1.7 1.7	25.7	15.4	13.9	UCFC207C UCFC207D	41	1 5/8	1.7			UCFC207FC UCFC207FD	50	1 31/32	2.1																	1 1/4	5 1/4	3.6220	4 3/8	3 3/32	15/32	1 1/32	23/64	7/16	1 17/32	1.937	0.748	UCFCX07-22 UCFCX07 UCFCX07-23	FCX07	UCX07-22 UCX07 UCX07-23	1.9 1.9 1.9	29.1	17.8	14.0	UCFCX07C UCFCX07D	43.5	1 23/32	1.9																								1 3/8	5 23/32	3.9370	4 23/32	3 11/32	35/64	1 1/32	7/16	25/64	1 5/8	1.937	0.748	UCFC208-24 UCFC208-25 UCFC208	FC208	UC208-24 UC208-25 UC208	2.0 2.0 2.0	29.1	17.8	14.0	UCFC208C UCFC208D	45.5	1 25/32	2.0			UCFC208FC UCFC208FD	54	2 1/8	2.4																	1 7/16	5 1/4	3.6220	4 3/8	3 3/32	15/32	1 1/32	23/64	7/16	1 17/32	1.937	0.748	UCFCX08-24 UCFCX08	FCX08	UCX08-24 UCX08	2.0 2.0	34.1	21.3	14.0	UCFCX08C UCFCX08D	43.5	1 23/32	2.0																						1 1/2	5 23/32	3.9370	4 23/32	3 11/32	35/64	1 1/32	7/16	25/64	1 5/8	1.937	0.748	UCFC209-26 UCFC209-27 UCFC209-28 UCFC209	FC209	UC209-26 UC209-27 UC209-28 UC209	2.6 2.6 2.6 2.6	34.1	21.3	14.0	UCFC209C UCFC209D	44.5	1 3/4	2.6			UCFC209FC UCFC209FD	54	2 1/8	3.0																	1 5/8	6 3/16	4.1339	5 13/64	3 43/64	5/8	1 1/32	25/64	15/32	1 19/32	1.937	0.748	UCFCX09-27 UCFCX09-28 UCFCX09	FCX09	UCX09-27 UCX09-28 UCX09	2.6 2.6 2.6	35.1	23.3	14.4	UCFCX09C UCFCX09D	45	1 25/32	2.6																						1 11/16	6 3/32	4.2520	5 1/8	3 5/8	35/64	31/32	5/16	15/32	1 19/32	2.031	0.748	UCFC210-30 UCFC210-31 UCFC210 UCFC210-32	FC210	UC210-30 UC210-31 UC210 UC210-32	2.9 2.9 2.9 2.9	35.1	23.3	14.4	UCFC210C UCFC210D	47	1 27/32	2.9			UCFC210FC UCFC210FD	58.5	2 5/16	3.4																		1 3/4	6 1/2	4.3307	5 7/16	3 27/32	5/8	1 3/32	25/64	15/32	1 11/16	2.031	0.748	UCFCX10-31 UCFCX10 UCFCX10-32	FCX10	UCX10-31 UCX10 UCX10-32	3.2 3.2 3.2	43.4	29.4	14.4	UCFCX10C UCFCX10D	45	1 25/32	3.2																						1 15/16	6 3/8	4.6457	5 23/64	3 25/32	35/64	31/32	9/32	5/8	1 19/32	2.189	0.874																													2	162	118	136	96.2	14	25	7	16	40.4	55.6	22.2	UCFCX10-31 UCFCX10 UCFCX10-32		UCX10-31 UCX10 UCX10-32	3.2 3.2 3.2	43.4	29.4	14.4	UCFCX10C UCFCX10D	45	1 25/32	3.2																					2																																					
15	5/8	3 15/16	2.4409	3 5/16	2 11/64	15/32	13/16	25/64	13/64	1 1/8	1.220	0.500	UCFC201-8 UCFC202 UCFC202-10 UCFC203 UCFC204-12 UCFC204		UC201-8 UC202 UC202-10 UC203 UC204-12 UC204	0.78 0.76 0.76 0.75 0.75 0.73	12.8	6.65	13.2	UCFC201C UCFC201D UCFC202C UCFC202D UCFC203C UCFC203D UCFC204C UCFC204D	32.5 32.5	1 9/32	0.78 0.76										17	3/4	100	62	78	55.1	12	20.5	10	5	28.3	31	12.7																					20													UCFC205-14 UCFC205-15 UCFC205 UCFC205-16	FC205	UC205-14 UC205-15 UC205 UC205-16	0.95 0.95 0.95 0.95	14.0	7.85	13.9								UCFC204FC UCFC204FD	41	1 17/32	0.84											25	7/8	4 17/32	2.7559	3 35/64	2 1/2	15/32	13/16	25/64	15/64	1 3/16	1.343	0.563	UCFC205-14 UCFC205-15 UCFC205 UCFC205-16		UC205-14 UC205-15 UC205 UC205-16	0.95 0.95 0.95 0.95	14.0	7.85	13.9	UCFC205C UCFC205D	34.5	1 11/32	0.95			UCFC205FC UCFC205FD	43	1 21/32	1.1											1 15/16												UCFCX05 UCFCX05-16	FCX05	UCX05 UCX05-16	1.2 1.2	19.5	11.3	13.9	UCFCX05C UCFCX05D	36.5	1 7/16	1.2																		1	4 3/8	2.9921	3 5/8	2 9/16	3/8	15/16	25/64	15/64	1 9/32	1.500	0.626	UCFC206-18 UCFC206 UCFC206-19 UCFC206-20	FC206	UC206-18 UC206 UC206-19 UC206-20	1.3 1.3 1.3 1.3	19.5	11.3	13.9	UCFC206C UCFC206D	36.5	1 7/16	1.3			UCFC206FC UCFC206FD	45	1 25/32	1.6														1 1/8	4 29/32	3.1496	3 15/16	2 25/32	15/32	29/32	25/64	5/16	1 9/32	1.500	0.626	UCFCX06 UCFCX06-19 UCFCX06-20	FCX06	UCX06 UCX06-19 UCX06-20	1.5 1.5 1.5	25.7	15.4	13.9	UCFCX06C UCFCX06D	38	1 1/2	1.5																						1 3/16	5	3.3465	4 9/64	2 59/64	15/32	7/8	5/16	3/8	1 5/16	1.689	0.689	UCFC207-20 UCFC207-21 UCFC207-22 UCFC207 UCFC207-23	FC207	UC207-20 UC207-21 UC207-22 UC207 UC207-23	1.7 1.7 1.7 1.7 1.7	25.7	15.4	13.9	UCFC207C UCFC207D	41	1 5/8	1.7			UCFC207FC UCFC207FD	50	1 31/32	2.1																	1 1/4	5 1/4	3.6220	4 3/8	3 3/32	15/32	1 1/32	23/64	7/16	1 17/32	1.937	0.748	UCFCX07-22 UCFCX07 UCFCX07-23	FCX07	UCX07-22 UCX07 UCX07-23	1.9 1.9 1.9	29.1	17.8	14.0	UCFCX07C UCFCX07D	43.5	1 23/32	1.9																								1 3/8	5 23/32	3.9370	4 23/32	3 11/32	35/64	1 1/32	7/16	25/64	1 5/8	1.937	0.748	UCFC208-24 UCFC208-25 UCFC208	FC208	UC208-24 UC208-25 UC208	2.0 2.0 2.0	29.1	17.8	14.0	UCFC208C UCFC208D	45.5	1 25/32	2.0			UCFC208FC UCFC208FD	54	2 1/8	2.4																	1 7/16	5 1/4	3.6220	4 3/8	3 3/32	15/32	1 1/32	23/64	7/16	1 17/32	1.937	0.748	UCFCX08-24 UCFCX08	FCX08	UCX08-24 UCX08	2.0 2.0	34.1	21.3	14.0	UCFCX08C UCFCX08D	43.5	1 23/32	2.0																						1 1/2	5 23/32	3.9370	4 23/32	3 11/32	35/64	1 1/32	7/16	25/64	1 5/8	1.937	0.748	UCFC209-26 UCFC209-27 UCFC209-28 UCFC209	FC209	UC209-26 UC209-27 UC209-28 UC209	2.6 2.6 2.6 2.6	34.1	21.3	14.0	UCFC209C UCFC209D	44.5	1 3/4	2.6			UCFC209FC UCFC209FD	54	2 1/8	3.0																	1 5/8	6 3/16	4.1339	5 13/64	3 43/64	5/8	1 1/32	25/64	15/32	1 19/32	1.937	0.748	UCFCX09-27 UCFCX09-28 UCFCX09	FCX09	UCX09-27 UCX09-28 UCX09	2.6 2.6 2.6	35.1	23.3	14.4	UCFCX09C UCFCX09D	45	1 25/32	2.6																						1 11/16	6 3/32	4.2520	5 1/8	3 5/8	35/64	31/32	5/16	15/32	1 19/32	2.031	0.748	UCFC210-30 UCFC210-31 UCFC210 UCFC210-32	FC210	UC210-30 UC210-31 UC210 UC210-32	2.9 2.9 2.9 2.9	35.1	23.3	14.4	UCFC210C UCFC210D	47	1 27/32	2.9			UCFC210FC UCFC210FD	58.5	2 5/16	3.4																		1 3/4	6 1/2	4.3307	5 7/16	3 27/32	5/8	1 3/32	25/64	15/32	1 11/16	2.031	0.748	UCFCX10-31 UCFCX10 UCFCX10-32	FCX10	UCX10-31 UCX10 UCX10-32	3.2 3.2 3.2	43.4	29.4	14.4	UCFCX10C UCFCX10D	45	1 25/32	3.2																						1 15/16	6 3/8	4.6457	5 23/64	3 25/32	35/64	31/32	9/32	5/8	1 19/32	2.189	0.874																													2	162	118	136	96.2	14	25	7	16	40.4	55.6	22.2	UCFCX10-31 UCFCX10 UCFCX10-32		UCX10-31 UCX10 UCX10-32	3.2 3.2 3.2	43.4	29.4	14.4	UCFCX10C UCFCX10D	45	1 25/32	3.2																					2																																																																						
17	3/4	100	62	78	55.1	12	20.5	10	5	28.3	31	12.7																					20													UCFC205-14 UCFC205-15 UCFC205 UCFC205-16	FC205	UC205-14 UC205-15 UC205 UC205-16	0.95 0.95 0.95 0.95	14.0	7.85	13.9								UCFC204FC UCFC204FD	41	1 17/32	0.84											25	7/8	4 17/32	2.7559	3 35/64	2 1/2	15/32	13/16	25/64	15/64	1 3/16	1.343	0.563	UCFC205-14 UCFC205-15 UCFC205 UCFC205-16		UC205-14 UC205-15 UC205 UC205-16	0.95 0.95 0.95 0.95	14.0	7.85	13.9	UCFC205C UCFC205D	34.5	1 11/32	0.95			UCFC205FC UCFC205FD	43	1 21/32	1.1											1 15/16												UCFCX05 UCFCX05-16	FCX05	UCX05 UCX05-16	1.2 1.2	19.5	11.3	13.9	UCFCX05C UCFCX05D	36.5	1 7/16	1.2																		1	4 3/8	2.9921	3 5/8	2 9/16	3/8	15/16	25/64	15/64	1 9/32	1.500	0.626	UCFC206-18 UCFC206 UCFC206-19 UCFC206-20	FC206	UC206-18 UC206 UC206-19 UC206-20	1.3 1.3 1.3 1.3	19.5	11.3	13.9	UCFC206C UCFC206D	36.5	1 7/16	1.3			UCFC206FC UCFC206FD	45	1 25/32	1.6														1 1/8	4 29/32	3.1496	3 15/16	2 25/32	15/32	29/32	25/64	5/16	1 9/32	1.500	0.626	UCFCX06 UCFCX06-19 UCFCX06-20	FCX06	UCX06 UCX06-19 UCX06-20	1.5 1.5 1.5	25.7	15.4	13.9	UCFCX06C UCFCX06D	38	1 1/2	1.5																						1 3/16	5	3.3465	4 9/64	2 59/64	15/32	7/8	5/16	3/8	1 5/16	1.689	0.689	UCFC207-20 UCFC207-21 UCFC207-22 UCFC207 UCFC207-23	FC207	UC207-20 UC207-21 UC207-22 UC207 UC207-23	1.7 1.7 1.7 1.7 1.7	25.7	15.4	13.9	UCFC207C UCFC207D	41	1 5/8	1.7			UCFC207FC UCFC207FD	50	1 31/32	2.1																	1 1/4	5 1/4	3.6220	4 3/8	3 3/32	15/32	1 1/32	23/64	7/16	1 17/32	1.937	0.748	UCFCX07-22 UCFCX07 UCFCX07-23	FCX07	UCX07-22 UCX07 UCX07-23	1.9 1.9 1.9	29.1	17.8	14.0	UCFCX07C UCFCX07D	43.5	1 23/32	1.9																								1 3/8	5 23/32	3.9370	4 23/32	3 11/32	35/64	1 1/32	7/16	25/64	1 5/8	1.937	0.748	UCFC208-24 UCFC208-25 UCFC208	FC208	UC208-24 UC208-25 UC208	2.0 2.0 2.0	29.1	17.8	14.0	UCFC208C UCFC208D	45.5	1 25/32	2.0			UCFC208FC UCFC208FD	54	2 1/8	2.4																	1 7/16	5 1/4	3.6220	4 3/8	3 3/32	15/32	1 1/32	23/64	7/16	1 17/32	1.937	0.748	UCFCX08-24 UCFCX08	FCX08	UCX08-24 UCX08	2.0 2.0	34.1	21.3	14.0	UCFCX08C UCFCX08D	43.5	1 23/32	2.0																						1 1/2	5 23/32	3.9370	4 23/32	3 11/32	35/64	1 1/32	7/16	25/64	1 5/8	1.937	0.748	UCFC209-26 UCFC209-27 UCFC209-28 UCFC209	FC209	UC209-26 UC209-27 UC209-28 UC209	2.6 2.6 2.6 2.6	34.1	21.3	14.0	UCFC209C UCFC209D	44.5	1 3/4	2.6			UCFC209FC UCFC209FD	54	2 1/8	3.0																	1 5/8	6 3/16	4.1339	5 13/64	3 43/64	5/8	1 1/32	25/64	15/32	1 19/32	1.937	0.748	UCFCX09-27 UCFCX09-28 UCFCX09	FCX09	UCX09-27 UCX09-28 UCX09	2.6 2.6 2.6	35.1	23.3	14.4	UCFCX09C UCFCX09D	45	1 25/32	2.6																						1 11/16	6 3/32	4.2520	5 1/8	3 5/8	35/64	31/32	5/16	15/32	1 19/32	2.031	0.748	UCFC210-30 UCFC210-31 UCFC210 UCFC210-32	FC210	UC210-30 UC210-31 UC210 UC210-32	2.9 2.9 2.9 2.9	35.1	23.3	14.4	UCFC210C UCFC210D	47	1 27/32	2.9			UCFC210FC UCFC210FD	58.5	2 5/16	3.4																		1 3/4	6 1/2	4.3307	5 7/16	3 27/32	5/8	1 3/32	25/64	15/32	1 11/16	2.031	0.748	UCFCX10-31 UCFCX10 UCFCX10-32	FCX10	UCX10-31 UCX10 UCX10-32	3.2 3.2 3.2	43.4	29.4	14.4	UCFCX10C UCFCX10D	45	1 25/32	3.2																						1 15/16	6 3/8	4.6457	5 23/64	3 25/32	35/64	31/32	9/32	5/8	1 19/32	2.189	0.874																													2	162	118	136	96.2	14	25	7	16	40.4	55.6	22.2	UCFCX10-31 UCFCX10 UCFCX10-32		UCX10-31 UCX10 UCX10-32	3.2 3.2 3.2	43.4	29.4	14.4	UCFCX10C UCFCX10D	45	1 25/32	3.2																					2																																																																																																							
20													UCFC205-14 UCFC205-15 UCFC205 UCFC205-16	FC205	UC205-14 UC205-15 UC205 UC205-16	0.95 0.95 0.95 0.95	14.0	7.85	13.9								UCFC204FC UCFC204FD	41	1 17/32	0.84											25	7/8	4 17/32	2.7559	3 35/64	2 1/2	15/32	13/16	25/64	15/64	1 3/16	1.343	0.563	UCFC205-14 UCFC205-15 UCFC205 UCFC205-16		UC205-14 UC205-15 UC205 UC205-16	0.95 0.95 0.95 0.95	14.0	7.85	13.9	UCFC205C UCFC205D	34.5	1 11/32	0.95			UCFC205FC UCFC205FD	43	1 21/32	1.1											1 15/16												UCFCX05 UCFCX05-16	FCX05	UCX05 UCX05-16	1.2 1.2	19.5	11.3	13.9	UCFCX05C UCFCX05D	36.5	1 7/16	1.2																		1	4 3/8	2.9921	3 5/8	2 9/16	3/8	15/16	25/64	15/64	1 9/32	1.500	0.626	UCFC206-18 UCFC206 UCFC206-19 UCFC206-20	FC206	UC206-18 UC206 UC206-19 UC206-20	1.3 1.3 1.3 1.3	19.5	11.3	13.9	UCFC206C UCFC206D	36.5	1 7/16	1.3			UCFC206FC UCFC206FD	45	1 25/32	1.6														1 1/8	4 29/32	3.1496	3 15/16	2 25/32	15/32	29/32	25/64	5/16	1 9/32	1.500	0.626	UCFCX06 UCFCX06-19 UCFCX06-20	FCX06	UCX06 UCX06-19 UCX06-20	1.5 1.5 1.5	25.7	15.4	13.9	UCFCX06C UCFCX06D	38	1 1/2	1.5																						1 3/16	5	3.3465	4 9/64	2 59/64	15/32	7/8	5/16	3/8	1 5/16	1.689	0.689	UCFC207-20 UCFC207-21 UCFC207-22 UCFC207 UCFC207-23	FC207	UC207-20 UC207-21 UC207-22 UC207 UC207-23	1.7 1.7 1.7 1.7 1.7	25.7	15.4	13.9	UCFC207C UCFC207D	41	1 5/8	1.7			UCFC207FC UCFC207FD	50	1 31/32	2.1																	1 1/4	5 1/4	3.6220	4 3/8	3 3/32	15/32	1 1/32	23/64	7/16	1 17/32	1.937	0.748	UCFCX07-22 UCFCX07 UCFCX07-23	FCX07	UCX07-22 UCX07 UCX07-23	1.9 1.9 1.9	29.1	17.8	14.0	UCFCX07C UCFCX07D	43.5	1 23/32	1.9																								1 3/8	5 23/32	3.9370	4 23/32	3 11/32	35/64	1 1/32	7/16	25/64	1 5/8	1.937	0.748	UCFC208-24 UCFC208-25 UCFC208	FC208	UC208-24 UC208-25 UC208	2.0 2.0 2.0	29.1	17.8	14.0	UCFC208C UCFC208D	45.5	1 25/32	2.0			UCFC208FC UCFC208FD	54	2 1/8	2.4																	1 7/16	5 1/4	3.6220	4 3/8	3 3/32	15/32	1 1/32	23/64	7/16	1 17/32	1.937	0.748	UCFCX08-24 UCFCX08	FCX08	UCX08-24 UCX08	2.0 2.0	34.1	21.3	14.0	UCFCX08C UCFCX08D	43.5	1 23/32	2.0																						1 1/2	5 23/32	3.9370	4 23/32	3 11/32	35/64	1 1/32	7/16	25/64	1 5/8	1.937	0.748	UCFC209-26 UCFC209-27 UCFC209-28 UCFC209	FC209	UC209-26 UC209-27 UC209-28 UC209	2.6 2.6 2.6 2.6	34.1	21.3	14.0	UCFC209C UCFC209D	44.5	1 3/4	2.6			UCFC209FC UCFC209FD	54	2 1/8	3.0																	1 5/8	6 3/16	4.1339	5 13/64	3 43/64	5/8	1 1/32	25/64	15/32	1 19/32	1.937	0.748	UCFCX09-27 UCFCX09-28 UCFCX09	FCX09	UCX09-27 UCX09-28 UCX09	2.6 2.6 2.6	35.1	23.3	14.4	UCFCX09C UCFCX09D	45	1 25/32	2.6																						1 11/16	6 3/32	4.2520	5 1/8	3 5/8	35/64	31/32	5/16	15/32	1 19/32	2.031	0.748	UCFC210-30 UCFC210-31 UCFC210 UCFC210-32	FC210	UC210-30 UC210-31 UC210 UC210-32	2.9 2.9 2.9 2.9	35.1	23.3	14.4	UCFC210C UCFC210D	47	1 27/32	2.9			UCFC210FC UCFC210FD	58.5	2 5/16	3.4																		1 3/4	6 1/2	4.3307	5 7/16	3 27/32	5/8	1 3/32	25/64	15/32	1 11/16	2.031	0.748	UCFCX10-31 UCFCX10 UCFCX10-32	FCX10	UCX10-31 UCX10 UCX10-32	3.2 3.2 3.2	43.4	29.4	14.4	UCFCX10C UCFCX10D	45	1 25/32	3.2																						1 15/16	6 3/8	4.6457	5 23/64	3 25/32	35/64	31/32	9/32	5/8	1 19/32	2.189	0.874																													2	162	118	136	96.2	14	25	7	16	40.4	55.6	22.2	UCFCX10-31 UCFCX10 UCFCX10-32		UCX10-31 UCX10 UCX10-32	3.2 3.2 3.2	43.4	29.4	14.4	UCFCX10C UCFCX10D	45	1 25/32	3.2																					2																																																																																																																																								
25	7/8	4 17/32	2.7559	3 35/64	2 1/2	15/32	13/16	25/64	15/64	1 3/16	1.343	0.563	UCFC205-14 UCFC205-15 UCFC205 UCFC205-16		UC205-14 UC205-15 UC205 UC205-16	0.95 0.95 0.95 0.95	14.0	7.85	13.9	UCFC205C UCFC205D	34.5	1 11/32	0.95			UCFC205FC UCFC205FD	43	1 21/32	1.1											1 15/16												UCFCX05 UCFCX05-16	FCX05	UCX05 UCX05-16	1.2 1.2	19.5	11.3	13.9	UCFCX05C UCFCX05D	36.5	1 7/16	1.2																		1	4 3/8	2.9921	3 5/8	2 9/16	3/8	15/16	25/64	15/64	1 9/32	1.500	0.626	UCFC206-18 UCFC206 UCFC206-19 UCFC206-20	FC206	UC206-18 UC206 UC206-19 UC206-20	1.3 1.3 1.3 1.3	19.5	11.3	13.9	UCFC206C UCFC206D	36.5	1 7/16	1.3			UCFC206FC UCFC206FD	45	1 25/32	1.6														1 1/8	4 29/32	3.1496	3 15/16	2 25/32	15/32	29/32	25/64	5/16	1 9/32	1.500	0.626	UCFCX06 UCFCX06-19 UCFCX06-20	FCX06	UCX06 UCX06-19 UCX06-20	1.5 1.5 1.5	25.7	15.4	13.9	UCFCX06C UCFCX06D	38	1 1/2	1.5																						1 3/16	5	3.3465	4 9/64	2 59/64	15/32	7/8	5/16	3/8	1 5/16	1.689	0.689	UCFC207-20 UCFC207-21 UCFC207-22 UCFC207 UCFC207-23	FC207	UC207-20 UC207-21 UC207-22 UC207 UC207-23	1.7 1.7 1.7 1.7 1.7	25.7	15.4	13.9	UCFC207C UCFC207D	41	1 5/8	1.7			UCFC207FC UCFC207FD	50	1 31/32	2.1																	1 1/4	5 1/4	3.6220	4 3/8	3 3/32	15/32	1 1/32	23/64	7/16	1 17/32	1.937	0.748	UCFCX07-22 UCFCX07 UCFCX07-23	FCX07	UCX07-22 UCX07 UCX07-23	1.9 1.9 1.9	29.1	17.8	14.0	UCFCX07C UCFCX07D	43.5	1 23/32	1.9																								1 3/8	5 23/32	3.9370	4 23/32	3 11/32	35/64	1 1/32	7/16	25/64	1 5/8	1.937	0.748	UCFC208-24 UCFC208-25 UCFC208	FC208	UC208-24 UC208-25 UC208	2.0 2.0 2.0	29.1	17.8	14.0	UCFC208C UCFC208D	45.5	1 25/32	2.0			UCFC208FC UCFC208FD	54	2 1/8	2.4																	1 7/16	5 1/4	3.6220	4 3/8	3 3/32	15/32	1 1/32	23/64	7/16	1 17/32	1.937	0.748	UCFCX08-24 UCFCX08	FCX08	UCX08-24 UCX08	2.0 2.0	34.1	21.3	14.0	UCFCX08C UCFCX08D	43.5	1 23/32	2.0																						1 1/2	5 23/32	3.9370	4 23/32	3 11/32	35/64	1 1/32	7/16	25/64	1 5/8	1.937	0.748	UCFC209-26 UCFC209-27 UCFC209-28 UCFC209	FC209	UC209-26 UC209-27 UC209-28 UC209	2.6 2.6 2.6 2.6	34.1	21.3	14.0	UCFC209C UCFC209D	44.5	1 3/4	2.6			UCFC209FC UCFC209FD	54	2 1/8	3.0																	1 5/8	6 3/16	4.1339	5 13/64	3 43/64	5/8	1 1/32	25/64	15/32	1 19/32	1.937	0.748	UCFCX09-27 UCFCX09-28 UCFCX09	FCX09	UCX09-27 UCX09-28 UCX09	2.6 2.6 2.6	35.1	23.3	14.4	UCFCX09C UCFCX09D	45	1 25/32	2.6																						1 11/16	6 3/32	4.2520	5 1/8	3 5/8	35/64	31/32	5/16	15/32	1 19/32	2.031	0.748	UCFC210-30 UCFC210-31 UCFC210 UCFC210-32	FC210	UC210-30 UC210-31 UC210 UC210-32	2.9 2.9 2.9 2.9	35.1	23.3	14.4	UCFC210C UCFC210D	47	1 27/32	2.9			UCFC210FC UCFC210FD	58.5	2 5/16	3.4																		1 3/4	6 1/2	4.3307	5 7/16	3 27/32	5/8	1 3/32	25/64	15/32	1 11/16	2.031	0.748	UCFCX10-31 UCFCX10 UCFCX10-32	FCX10	UCX10-31 UCX10 UCX10-32	3.2 3.2 3.2	43.4	29.4	14.4	UCFCX10C UCFCX10D	45	1 25/32	3.2																						1 15/16	6 3/8	4.6457	5 23/64	3 25/32	35/64	31/32	9/32	5/8	1 19/32	2.189	0.874																													2	162	118	136	96.2	14	25	7	16	40.4	55.6	22.2	UCFCX10-31 UCFCX10 UCFCX10-32		UCX10-31 UCX10 UCX10-32	3.2 3.2 3.2	43.4	29.4	14.4	UCFCX10C UCFCX10D	45	1 25/32	3.2																					2																																																																																																																																																																																	
	1 15/16												UCFCX05 UCFCX05-16	FCX05	UCX05 UCX05-16	1.2 1.2	19.5	11.3	13.9	UCFCX05C UCFCX05D	36.5	1 7/16	1.2																		1	4 3/8	2.9921	3 5/8	2 9/16	3/8	15/16	25/64	15/64	1 9/32	1.500	0.626	UCFC206-18 UCFC206 UCFC206-19 UCFC206-20	FC206	UC206-18 UC206 UC206-19 UC206-20	1.3 1.3 1.3 1.3	19.5	11.3	13.9	UCFC206C UCFC206D	36.5	1 7/16	1.3			UCFC206FC UCFC206FD	45	1 25/32	1.6														1 1/8	4 29/32	3.1496	3 15/16	2 25/32	15/32	29/32	25/64	5/16	1 9/32	1.500	0.626	UCFCX06 UCFCX06-19 UCFCX06-20	FCX06	UCX06 UCX06-19 UCX06-20	1.5 1.5 1.5	25.7	15.4	13.9	UCFCX06C UCFCX06D	38	1 1/2	1.5																						1 3/16	5	3.3465	4 9/64	2 59/64	15/32	7/8	5/16	3/8	1 5/16	1.689	0.689	UCFC207-20 UCFC207-21 UCFC207-22 UCFC207 UCFC207-23	FC207	UC207-20 UC207-21 UC207-22 UC207 UC207-23	1.7 1.7 1.7 1.7 1.7	25.7	15.4	13.9	UCFC207C UCFC207D	41	1 5/8	1.7			UCFC207FC UCFC207FD	50	1 31/32	2.1																	1 1/4	5 1/4	3.6220	4 3/8	3 3/32	15/32	1 1/32	23/64	7/16	1 17/32	1.937	0.748	UCFCX07-22 UCFCX07 UCFCX07-23	FCX07	UCX07-22 UCX07 UCX07-23	1.9 1.9 1.9	29.1	17.8	14.0	UCFCX07C UCFCX07D	43.5	1 23/32	1.9																								1 3/8	5 23/32	3.9370	4 23/32	3 11/32	35/64	1 1/32	7/16	25/64	1 5/8	1.937	0.748	UCFC208-24 UCFC208-25 UCFC208	FC208	UC208-24 UC208-25 UC208	2.0 2.0 2.0	29.1	17.8	14.0	UCFC208C UCFC208D	45.5	1 25/32	2.0			UCFC208FC UCFC208FD	54	2 1/8	2.4																	1 7/16	5 1/4	3.6220	4 3/8	3 3/32	15/32	1 1/32	23/64	7/16	1 17/32	1.937	0.748	UCFCX08-24 UCFCX08	FCX08	UCX08-24 UCX08	2.0 2.0	34.1	21.3	14.0	UCFCX08C UCFCX08D	43.5	1 23/32	2.0																						1 1/2	5 23/32	3.9370	4 23/32	3 11/32	35/64	1 1/32	7/16	25/64	1 5/8	1.937	0.748	UCFC209-26 UCFC209-27 UCFC209-28 UCFC209	FC209	UC209-26 UC209-27 UC209-28 UC209	2.6 2.6 2.6 2.6	34.1	21.3	14.0	UCFC209C UCFC209D	44.5	1 3/4	2.6			UCFC209FC UCFC209FD	54	2 1/8	3.0																	1 5/8	6 3/16	4.1339	5 13/64	3 43/64	5/8	1 1/32	25/64	15/32	1 19/32	1.937	0.748	UCFCX09-27 UCFCX09-28 UCFCX09	FCX09	UCX09-27 UCX09-28 UCX09	2.6 2.6 2.6	35.1	23.3	14.4	UCFCX09C UCFCX09D	45	1 25/32	2.6																						1 11/16	6 3/32	4.2520	5 1/8	3 5/8	35/64	31/32	5/16	15/32	1 19/32	2.031	0.748	UCFC210-30 UCFC210-31 UCFC210 UCFC210-32	FC210	UC210-30 UC210-31 UC210 UC210-32	2.9 2.9 2.9 2.9	35.1	23.3	14.4	UCFC210C UCFC210D	47	1 27/32	2.9			UCFC210FC UCFC210FD	58.5	2 5/16	3.4																		1 3/4	6 1/2	4.3307	5 7/16	3 27/32	5/8	1 3/32	25/64	15/32	1 11/16	2.031	0.748	UCFCX10-31 UCFCX10 UCFCX10-32	FCX10	UCX10-31 UCX10 UCX10-32	3.2 3.2 3.2	43.4	29.4	14.4	UCFCX10C UCFCX10D	45	1 25/32	3.2																						1 15/16	6 3/8	4.6457	5 23/64	3 25/32	35/64	31/32	9/32	5/8	1 19/32	2.189	0.874																													2	162	118	136	96.2	14	25	7	16	40.4	55.6	22.2	UCFCX10-31 UCFCX10 UCFCX10-32		UCX10-31 UCX10 UCX10-32	3.2 3.2 3.2	43.4	29.4	14.4	UCFCX10C UCFCX10D	45	1 25/32	3.2																					2																																																																																																																																																																																																																								
	1	4 3/8	2.9921	3 5/8	2 9/16	3/8	15/16	25/64	15/64	1 9/32	1.500	0.626	UCFC206-18 UCFC206 UCFC206-19 UCFC206-20	FC206	UC206-18 UC206 UC206-19 UC206-20	1.3 1.3 1.3 1.3	19.5	11.3	13.9	UCFC206C UCFC206D	36.5	1 7/16	1.3			UCFC206FC UCFC206FD	45	1 25/32	1.6														1 1/8	4 29/32	3.1496	3 15/16	2 25/32	15/32	29/32	25/64	5/16	1 9/32	1.500	0.626	UCFCX06 UCFCX06-19 UCFCX06-20	FCX06	UCX06 UCX06-19 UCX06-20	1.5 1.5 1.5	25.7	15.4	13.9	UCFCX06C UCFCX06D	38	1 1/2	1.5																						1 3/16	5	3.3465	4 9/64	2 59/64	15/32	7/8	5/16	3/8	1 5/16	1.689	0.689	UCFC207-20 UCFC207-21 UCFC207-22 UCFC207 UCFC207-23	FC207	UC207-20 UC207-21 UC207-22 UC207 UC207-23	1.7 1.7 1.7 1.7 1.7	25.7	15.4	13.9	UCFC207C UCFC207D	41	1 5/8	1.7			UCFC207FC UCFC207FD	50	1 31/32	2.1																	1 1/4	5 1/4	3.6220	4 3/8	3 3/32	15/32	1 1/32	23/64	7/16	1 17/32	1.937	0.748	UCFCX07-22 UCFCX07 UCFCX07-23	FCX07	UCX07-22 UCX07 UCX07-23	1.9 1.9 1.9	29.1	17.8	14.0	UCFCX07C UCFCX07D	43.5	1 23/32	1.9																								1 3/8	5 23/32	3.9370	4 23/32	3 11/32	35/64	1 1/32	7/16	25/64	1 5/8	1.937	0.748	UCFC208-24 UCFC208-25 UCFC208	FC208	UC208-24 UC208-25 UC208	2.0 2.0 2.0	29.1	17.8	14.0	UCFC208C UCFC208D	45.5	1 25/32	2.0			UCFC208FC UCFC208FD	54	2 1/8	2.4																	1 7/16	5 1/4	3.6220	4 3/8	3 3/32	15/32	1 1/32	23/64	7/16	1 17/32	1.937	0.748	UCFCX08-24 UCFCX08	FCX08	UCX08-24 UCX08	2.0 2.0	34.1	21.3	14.0	UCFCX08C UCFCX08D	43.5	1 23/32	2.0																						1 1/2	5 23/32	3.9370	4 23/32	3 11/32	35/64	1 1/32	7/16	25/64	1 5/8	1.937	0.748	UCFC209-26 UCFC209-27 UCFC209-28 UCFC209	FC209	UC209-26 UC209-27 UC209-28 UC209	2.6 2.6 2.6 2.6	34.1	21.3	14.0	UCFC209C UCFC209D	44.5	1 3/4	2.6			UCFC209FC UCFC209FD	54	2 1/8	3.0																	1 5/8	6 3/16	4.1339	5 13/64	3 43/64	5/8	1 1/32	25/64	15/32	1 19/32	1.937	0.748	UCFCX09-27 UCFCX09-28 UCFCX09	FCX09	UCX09-27 UCX09-28 UCX09	2.6 2.6 2.6	35.1	23.3	14.4	UCFCX09C UCFCX09D	45	1 25/32	2.6																						1 11/16	6 3/32	4.2520	5 1/8	3 5/8	35/64	31/32	5/16	15/32	1 19/32	2.031	0.748	UCFC210-30 UCFC210-31 UCFC210 UCFC210-32	FC210	UC210-30 UC210-31 UC210 UC210-32	2.9 2.9 2.9 2.9	35.1	23.3	14.4	UCFC210C UCFC210D	47	1 27/32	2.9			UCFC210FC UCFC210FD	58.5	2 5/16	3.4																		1 3/4	6 1/2	4.3307	5 7/16	3 27/32	5/8	1 3/32	25/64	15/32	1 11/16	2.031	0.748	UCFCX10-31 UCFCX10 UCFCX10-32	FCX10	UCX10-31 UCX10 UCX10-32	3.2 3.2 3.2	43.4	29.4	14.4	UCFCX10C UCFCX10D	45	1 25/32	3.2																						1 15/16	6 3/8	4.6457	5 23/64	3 25/32	35/64	31/32	9/32	5/8	1 19/32	2.189	0.874																													2	162	118	136	96.2	14	25	7	16	40.4	55.6	22.2	UCFCX10-31 UCFCX10 UCFCX10-32		UCX10-31 UCX10 UCX10-32	3.2 3.2 3.2	43.4	29.4	14.4	UCFCX10C UCFCX10D	45	1 25/32	3.2																					2																																																																																																																																																																																																																																																																
	1 1/8	4 29/32	3.1496	3 15/16	2 25/32	15/32	29/32	25/64	5/16	1 9/32	1.500	0.626	UCFCX06 UCFCX06-19 UCFCX06-20	FCX06	UCX06 UCX06-19 UCX06-20	1.5 1.5 1.5	25.7	15.4	13.9	UCFCX06C UCFCX06D	38	1 1/2	1.5																						1 3/16	5	3.3465	4 9/64	2 59/64	15/32	7/8	5/16	3/8	1 5/16	1.689	0.689	UCFC207-20 UCFC207-21 UCFC207-22 UCFC207 UCFC207-23	FC207	UC207-20 UC207-21 UC207-22 UC207 UC207-23	1.7 1.7 1.7 1.7 1.7	25.7	15.4	13.9	UCFC207C UCFC207D	41	1 5/8	1.7			UCFC207FC UCFC207FD	50	1 31/32	2.1																	1 1/4	5 1/4	3.6220	4 3/8	3 3/32	15/32	1 1/32	23/64	7/16	1 17/32	1.937	0.748	UCFCX07-22 UCFCX07 UCFCX07-23	FCX07	UCX07-22 UCX07 UCX07-23	1.9 1.9 1.9	29.1	17.8	14.0	UCFCX07C UCFCX07D	43.5	1 23/32	1.9																								1 3/8	5 23/32	3.9370	4 23/32	3 11/32	35/64	1 1/32	7/16	25/64	1 5/8	1.937	0.748	UCFC208-24 UCFC208-25 UCFC208	FC208	UC208-24 UC208-25 UC208	2.0 2.0 2.0	29.1	17.8	14.0	UCFC208C UCFC208D	45.5	1 25/32	2.0			UCFC208FC UCFC208FD	54	2 1/8	2.4																	1 7/16	5 1/4	3.6220	4 3/8	3 3/32	15/32	1 1/32	23/64	7/16	1 17/32	1.937	0.748	UCFCX08-24 UCFCX08	FCX08	UCX08-24 UCX08	2.0 2.0	34.1	21.3	14.0	UCFCX08C UCFCX08D	43.5	1 23/32	2.0																						1 1/2	5 23/32	3.9370	4 23/32	3 11/32	35/64	1 1/32	7/16	25/64	1 5/8	1.937	0.748	UCFC209-26 UCFC209-27 UCFC209-28 UCFC209	FC209	UC209-26 UC209-27 UC209-28 UC209	2.6 2.6 2.6 2.6	34.1	21.3	14.0	UCFC209C UCFC209D	44.5	1 3/4	2.6			UCFC209FC UCFC209FD	54	2 1/8	3.0																	1 5/8	6 3/16	4.1339	5 13/64	3 43/64	5/8	1 1/32	25/64	15/32	1 19/32	1.937	0.748	UCFCX09-27 UCFCX09-28 UCFCX09	FCX09	UCX09-27 UCX09-28 UCX09	2.6 2.6 2.6	35.1	23.3	14.4	UCFCX09C UCFCX09D	45	1 25/32	2.6																						1 11/16	6 3/32	4.2520	5 1/8	3 5/8	35/64	31/32	5/16	15/32	1 19/32	2.031	0.748	UCFC210-30 UCFC210-31 UCFC210 UCFC210-32	FC210	UC210-30 UC210-31 UC210 UC210-32	2.9 2.9 2.9 2.9	35.1	23.3	14.4	UCFC210C UCFC210D	47	1 27/32	2.9			UCFC210FC UCFC210FD	58.5	2 5/16	3.4																		1 3/4	6 1/2	4.3307	5 7/16	3 27/32	5/8	1 3/32	25/64	15/32	1 11/16	2.031	0.748	UCFCX10-31 UCFCX10 UCFCX10-32	FCX10	UCX10-31 UCX10 UCX10-32	3.2 3.2 3.2	43.4	29.4	14.4	UCFCX10C UCFCX10D	45	1 25/32	3.2																						1 15/16	6 3/8	4.6457	5 23/64	3 25/32	35/64	31/32	9/32	5/8	1 19/32	2.189	0.874																													2	162	118	136	96.2	14	25	7	16	40.4	55.6	22.2	UCFCX10-31 UCFCX10 UCFCX10-32		UCX10-31 UCX10 UCX10-32	3.2 3.2 3.2	43.4	29.4	14.4	UCFCX10C UCFCX10D	45	1 25/32	3.2																					2																																																																																																																																																																																																																																																																																																										
	1 3/16	5	3.3465	4 9/64	2 59/64	15/32	7/8	5/16	3/8	1 5/16	1.689	0.689	UCFC207-20 UCFC207-21 UCFC207-22 UCFC207 UCFC207-23	FC207	UC207-20 UC207-21 UC207-22 UC207 UC207-23	1.7 1.7 1.7 1.7 1.7	25.7	15.4	13.9	UCFC207C UCFC207D	41	1 5/8	1.7			UCFC207FC UCFC207FD	50	1 31/32	2.1																	1 1/4	5 1/4	3.6220	4 3/8	3 3/32	15/32	1 1/32	23/64	7/16	1 17/32	1.937	0.748	UCFCX07-22 UCFCX07 UCFCX07-23	FCX07	UCX07-22 UCX07 UCX07-23	1.9 1.9 1.9	29.1	17.8	14.0	UCFCX07C UCFCX07D	43.5	1 23/32	1.9																								1 3/8	5 23/32	3.9370	4 23/32	3 11/32	35/64	1 1/32	7/16	25/64	1 5/8	1.937	0.748	UCFC208-24 UCFC208-25 UCFC208	FC208	UC208-24 UC208-25 UC208	2.0 2.0 2.0	29.1	17.8	14.0	UCFC208C UCFC208D	45.5	1 25/32	2.0			UCFC208FC UCFC208FD	54	2 1/8	2.4																	1 7/16	5 1/4	3.6220	4 3/8	3 3/32	15/32	1 1/32	23/64	7/16	1 17/32	1.937	0.748	UCFCX08-24 UCFCX08	FCX08	UCX08-24 UCX08	2.0 2.0	34.1	21.3	14.0	UCFCX08C UCFCX08D	43.5	1 23/32	2.0																						1 1/2	5 23/32	3.9370	4 23/32	3 11/32	35/64	1 1/32	7/16	25/64	1 5/8	1.937	0.748	UCFC209-26 UCFC209-27 UCFC209-28 UCFC209	FC209	UC209-26 UC209-27 UC209-28 UC209	2.6 2.6 2.6 2.6	34.1	21.3	14.0	UCFC209C UCFC209D	44.5	1 3/4	2.6			UCFC209FC UCFC209FD	54	2 1/8	3.0																	1 5/8	6 3/16	4.1339	5 13/64	3 43/64	5/8	1 1/32	25/64	15/32	1 19/32	1.937	0.748	UCFCX09-27 UCFCX09-28 UCFCX09	FCX09	UCX09-27 UCX09-28 UCX09	2.6 2.6 2.6	35.1	23.3	14.4	UCFCX09C UCFCX09D	45	1 25/32	2.6																						1 11/16	6 3/32	4.2520	5 1/8	3 5/8	35/64	31/32	5/16	15/32	1 19/32	2.031	0.748	UCFC210-30 UCFC210-31 UCFC210 UCFC210-32	FC210	UC210-30 UC210-31 UC210 UC210-32	2.9 2.9 2.9 2.9	35.1	23.3	14.4	UCFC210C UCFC210D	47	1 27/32	2.9			UCFC210FC UCFC210FD	58.5	2 5/16	3.4																		1 3/4	6 1/2	4.3307	5 7/16	3 27/32	5/8	1 3/32	25/64	15/32	1 11/16	2.031	0.748	UCFCX10-31 UCFCX10 UCFCX10-32	FCX10	UCX10-31 UCX10 UCX10-32	3.2 3.2 3.2	43.4	29.4	14.4	UCFCX10C UCFCX10D	45	1 25/32	3.2																						1 15/16	6 3/8	4.6457	5 23/64	3 25/32	35/64	31/32	9/32	5/8	1 19/32	2.189	0.874																													2	162	118	136	96.2	14	25	7	16	40.4	55.6	22.2	UCFCX10-31 UCFCX10 UCFCX10-32		UCX10-31 UCX10 UCX10-32	3.2 3.2 3.2	43.4	29.4	14.4	UCFCX10C UCFCX10D	45	1 25/32	3.2																					2																																																																																																																																																																																																																																																																																																																																																						
	1 1/4	5 1/4	3.6220	4 3/8	3 3/32	15/32	1 1/32	23/64	7/16	1 17/32	1.937	0.748	UCFCX07-22 UCFCX07 UCFCX07-23	FCX07	UCX07-22 UCX07 UCX07-23	1.9 1.9 1.9	29.1	17.8	14.0	UCFCX07C UCFCX07D	43.5	1 23/32	1.9																								1 3/8	5 23/32	3.9370	4 23/32	3 11/32	35/64	1 1/32	7/16	25/64	1 5/8	1.937	0.748	UCFC208-24 UCFC208-25 UCFC208	FC208	UC208-24 UC208-25 UC208	2.0 2.0 2.0	29.1	17.8	14.0	UCFC208C UCFC208D	45.5	1 25/32	2.0			UCFC208FC UCFC208FD	54	2 1/8	2.4																	1 7/16	5 1/4	3.6220	4 3/8	3 3/32	15/32	1 1/32	23/64	7/16	1 17/32	1.937	0.748	UCFCX08-24 UCFCX08	FCX08	UCX08-24 UCX08	2.0 2.0	34.1	21.3	14.0	UCFCX08C UCFCX08D	43.5	1 23/32	2.0																						1 1/2	5 23/32	3.9370	4 23/32	3 11/32	35/64	1 1/32	7/16	25/64	1 5/8	1.937	0.748	UCFC209-26 UCFC209-27 UCFC209-28 UCFC209	FC209	UC209-26 UC209-27 UC209-28 UC209	2.6 2.6 2.6 2.6	34.1	21.3	14.0	UCFC209C UCFC209D	44.5	1 3/4	2.6			UCFC209FC UCFC209FD	54	2 1/8	3.0																	1 5/8	6 3/16	4.1339	5 13/64	3 43/64	5/8	1 1/32	25/64	15/32	1 19/32	1.937	0.748	UCFCX09-27 UCFCX09-28 UCFCX09	FCX09	UCX09-27 UCX09-28 UCX09	2.6 2.6 2.6	35.1	23.3	14.4	UCFCX09C UCFCX09D	45	1 25/32	2.6																						1 11/16	6 3/32	4.2520	5 1/8	3 5/8	35/64	31/32	5/16	15/32	1 19/32	2.031	0.748	UCFC210-30 UCFC210-31 UCFC210 UCFC210-32	FC210	UC210-30 UC210-31 UC210 UC210-32	2.9 2.9 2.9 2.9	35.1	23.3	14.4	UCFC210C UCFC210D	47	1 27/32	2.9			UCFC210FC UCFC210FD	58.5	2 5/16	3.4																		1 3/4	6 1/2	4.3307	5 7/16	3 27/32	5/8	1 3/32	25/64	15/32	1 11/16	2.031	0.748	UCFCX10-31 UCFCX10 UCFCX10-32	FCX10	UCX10-31 UCX10 UCX10-32	3.2 3.2 3.2	43.4	29.4	14.4	UCFCX10C UCFCX10D	45	1 25/32	3.2																						1 15/16	6 3/8	4.6457	5 23/64	3 25/32	35/64	31/32	9/32	5/8	1 19/32	2.189	0.874																													2	162	118	136	96.2	14	25	7	16	40.4	55.6	22.2	UCFCX10-31 UCFCX10 UCFCX10-32		UCX10-31 UCX10 UCX10-32	3.2 3.2 3.2	43.4	29.4	14.4	UCFCX10C UCFCX10D	45	1 25/32	3.2																					2																																																																																																																																																																																																																																																																																																																																																																																																			
	1 3/8	5 23/32	3.9370	4 23/32	3 11/32	35/64	1 1/32	7/16	25/64	1 5/8	1.937	0.748	UCFC208-24 UCFC208-25 UCFC208	FC208	UC208-24 UC208-25 UC208	2.0 2.0 2.0	29.1	17.8	14.0	UCFC208C UCFC208D	45.5	1 25/32	2.0			UCFC208FC UCFC208FD	54	2 1/8	2.4																	1 7/16	5 1/4	3.6220	4 3/8	3 3/32	15/32	1 1/32	23/64	7/16	1 17/32	1.937	0.748	UCFCX08-24 UCFCX08	FCX08	UCX08-24 UCX08	2.0 2.0	34.1	21.3	14.0	UCFCX08C UCFCX08D	43.5	1 23/32	2.0																						1 1/2	5 23/32	3.9370	4 23/32	3 11/32	35/64	1 1/32	7/16	25/64	1 5/8	1.937	0.748	UCFC209-26 UCFC209-27 UCFC209-28 UCFC209	FC209	UC209-26 UC209-27 UC209-28 UC209	2.6 2.6 2.6 2.6	34.1	21.3	14.0	UCFC209C UCFC209D	44.5	1 3/4	2.6			UCFC209FC UCFC209FD	54	2 1/8	3.0																	1 5/8	6 3/16	4.1339	5 13/64	3 43/64	5/8	1 1/32	25/64	15/32	1 19/32	1.937	0.748	UCFCX09-27 UCFCX09-28 UCFCX09	FCX09	UCX09-27 UCX09-28 UCX09	2.6 2.6 2.6	35.1	23.3	14.4	UCFCX09C UCFCX09D	45	1 25/32	2.6																						1 11/16	6 3/32	4.2520	5 1/8	3 5/8	35/64	31/32	5/16	15/32	1 19/32	2.031	0.748	UCFC210-30 UCFC210-31 UCFC210 UCFC210-32	FC210	UC210-30 UC210-31 UC210 UC210-32	2.9 2.9 2.9 2.9	35.1	23.3	14.4	UCFC210C UCFC210D	47	1 27/32	2.9			UCFC210FC UCFC210FD	58.5	2 5/16	3.4																		1 3/4	6 1/2	4.3307	5 7/16	3 27/32	5/8	1 3/32	25/64	15/32	1 11/16	2.031	0.748	UCFCX10-31 UCFCX10 UCFCX10-32	FCX10	UCX10-31 UCX10 UCX10-32	3.2 3.2 3.2	43.4	29.4	14.4	UCFCX10C UCFCX10D	45	1 25/32	3.2																						1 15/16	6 3/8	4.6457	5 23/64	3 25/32	35/64	31/32	9/32	5/8	1 19/32	2.189	0.874																													2	162	118	136	96.2	14	25	7	16	40.4	55.6	22.2	UCFCX10-31 UCFCX10 UCFCX10-32		UCX10-31 UCX10 UCX10-32	3.2 3.2 3.2	43.4	29.4	14.4	UCFCX10C UCFCX10D	45	1 25/32	3.2																					2																																																																																																																																																																																																																																																																																																																																																																																																																																																	
	1 7/16	5 1/4	3.6220	4 3/8	3 3/32	15/32	1 1/32	23/64	7/16	1 17/32	1.937	0.748	UCFCX08-24 UCFCX08	FCX08	UCX08-24 UCX08	2.0 2.0	34.1	21.3	14.0	UCFCX08C UCFCX08D	43.5	1 23/32	2.0																						1 1/2	5 23/32	3.9370	4 23/32	3 11/32	35/64	1 1/32	7/16	25/64	1 5/8	1.937	0.748	UCFC209-26 UCFC209-27 UCFC209-28 UCFC209	FC209	UC209-26 UC209-27 UC209-28 UC209	2.6 2.6 2.6 2.6	34.1	21.3	14.0	UCFC209C UCFC209D	44.5	1 3/4	2.6			UCFC209FC UCFC209FD	54	2 1/8	3.0																	1 5/8	6 3/16	4.1339	5 13/64	3 43/64	5/8	1 1/32	25/64	15/32	1 19/32	1.937	0.748	UCFCX09-27 UCFCX09-28 UCFCX09	FCX09	UCX09-27 UCX09-28 UCX09	2.6 2.6 2.6	35.1	23.3	14.4	UCFCX09C UCFCX09D	45	1 25/32	2.6																						1 11/16	6 3/32	4.2520	5 1/8	3 5/8	35/64	31/32	5/16	15/32	1 19/32	2.031	0.748	UCFC210-30 UCFC210-31 UCFC210 UCFC210-32	FC210	UC210-30 UC210-31 UC210 UC210-32	2.9 2.9 2.9 2.9	35.1	23.3	14.4	UCFC210C UCFC210D	47	1 27/32	2.9			UCFC210FC UCFC210FD	58.5	2 5/16	3.4																		1 3/4	6 1/2	4.3307	5 7/16	3 27/32	5/8	1 3/32	25/64	15/32	1 11/16	2.031	0.748	UCFCX10-31 UCFCX10 UCFCX10-32	FCX10	UCX10-31 UCX10 UCX10-32	3.2 3.2 3.2	43.4	29.4	14.4	UCFCX10C UCFCX10D	45	1 25/32	3.2																						1 15/16	6 3/8	4.6457	5 23/64	3 25/32	35/64	31/32	9/32	5/8	1 19/32	2.189	0.874																													2	162	118	136	96.2	14	25	7	16	40.4	55.6	22.2	UCFCX10-31 UCFCX10 UCFCX10-32		UCX10-31 UCX10 UCX10-32	3.2 3.2 3.2	43.4	29.4	14.4	UCFCX10C UCFCX10D	45	1 25/32	3.2																					2																																																																																																																																																																																																																																																																																																																																																																																																																																																																																														
	1 1/2	5 23/32	3.9370	4 23/32	3 11/32	35/64	1 1/32	7/16	25/64	1 5/8	1.937	0.748	UCFC209-26 UCFC209-27 UCFC209-28 UCFC209	FC209	UC209-26 UC209-27 UC209-28 UC209	2.6 2.6 2.6 2.6	34.1	21.3	14.0	UCFC209C UCFC209D	44.5	1 3/4	2.6			UCFC209FC UCFC209FD	54	2 1/8	3.0																	1 5/8	6 3/16	4.1339	5 13/64	3 43/64	5/8	1 1/32	25/64	15/32	1 19/32	1.937	0.748	UCFCX09-27 UCFCX09-28 UCFCX09	FCX09	UCX09-27 UCX09-28 UCX09	2.6 2.6 2.6	35.1	23.3	14.4	UCFCX09C UCFCX09D	45	1 25/32	2.6																						1 11/16	6 3/32	4.2520	5 1/8	3 5/8	35/64	31/32	5/16	15/32	1 19/32	2.031	0.748	UCFC210-30 UCFC210-31 UCFC210 UCFC210-32	FC210	UC210-30 UC210-31 UC210 UC210-32	2.9 2.9 2.9 2.9	35.1	23.3	14.4	UCFC210C UCFC210D	47	1 27/32	2.9			UCFC210FC UCFC210FD	58.5	2 5/16	3.4																		1 3/4	6 1/2	4.3307	5 7/16	3 27/32	5/8	1 3/32	25/64	15/32	1 11/16	2.031	0.748	UCFCX10-31 UCFCX10 UCFCX10-32	FCX10	UCX10-31 UCX10 UCX10-32	3.2 3.2 3.2	43.4	29.4	14.4	UCFCX10C UCFCX10D	45	1 25/32	3.2																						1 15/16	6 3/8	4.6457	5 23/64	3 25/32	35/64	31/32	9/32	5/8	1 19/32	2.189	0.874																													2	162	118	136	96.2	14	25	7	16	40.4	55.6	22.2	UCFCX10-31 UCFCX10 UCFCX10-32		UCX10-31 UCX10 UCX10-32	3.2 3.2 3.2	43.4	29.4	14.4	UCFCX10C UCFCX10D	45	1 25/32	3.2																					2																																																																																																																																																																																																																																																																																																																																																																																																																																																																																																																																										
	1 5/8	6 3/16	4.1339	5 13/64	3 43/64	5/8	1 1/32	25/64	15/32	1 19/32	1.937	0.748	UCFCX09-27 UCFCX09-28 UCFCX09	FCX09	UCX09-27 UCX09-28 UCX09	2.6 2.6 2.6	35.1	23.3	14.4	UCFCX09C UCFCX09D	45	1 25/32	2.6																						1 11/16	6 3/32	4.2520	5 1/8	3 5/8	35/64	31/32	5/16	15/32	1 19/32	2.031	0.748	UCFC210-30 UCFC210-31 UCFC210 UCFC210-32	FC210	UC210-30 UC210-31 UC210 UC210-32	2.9 2.9 2.9 2.9	35.1	23.3	14.4	UCFC210C UCFC210D	47	1 27/32	2.9			UCFC210FC UCFC210FD	58.5	2 5/16	3.4																		1 3/4	6 1/2	4.3307	5 7/16	3 27/32	5/8	1 3/32	25/64	15/32	1 11/16	2.031	0.748	UCFCX10-31 UCFCX10 UCFCX10-32	FCX10	UCX10-31 UCX10 UCX10-32	3.2 3.2 3.2	43.4	29.4	14.4	UCFCX10C UCFCX10D	45	1 25/32	3.2																						1 15/16	6 3/8	4.6457	5 23/64	3 25/32	35/64	31/32	9/32	5/8	1 19/32	2.189	0.874																													2	162	118	136	96.2	14	25	7	16	40.4	55.6	22.2	UCFCX10-31 UCFCX10 UCFCX10-32		UCX10-31 UCX10 UCX10-32	3.2 3.2 3.2	43.4	29.4	14.4	UCFCX10C UCFCX10D	45	1 25/32	3.2																					2																																																																																																																																																																																																																																																																																																																																																																																																																																																																																																																																																																																							
	1 11/16	6 3/32	4.2520	5 1/8	3 5/8	35/64	31/32	5/16	15/32	1 19/32	2.031	0.748	UCFC210-30 UCFC210-31 UCFC210 UCFC210-32	FC210	UC210-30 UC210-31 UC210 UC210-32	2.9 2.9 2.9 2.9	35.1	23.3	14.4	UCFC210C UCFC210D	47	1 27/32	2.9			UCFC210FC UCFC210FD	58.5	2 5/16	3.4																		1 3/4	6 1/2	4.3307	5 7/16	3 27/32	5/8	1 3/32	25/64	15/32	1 11/16	2.031	0.748	UCFCX10-31 UCFCX10 UCFCX10-32	FCX10	UCX10-31 UCX10 UCX10-32	3.2 3.2 3.2	43.4	29.4	14.4	UCFCX10C UCFCX10D	45	1 25/32	3.2																						1 15/16	6 3/8	4.6457	5 23/64	3 25/32	35/64	31/32	9/32	5/8	1 19/32	2.189	0.874																													2	162	118	136	96.2	14	25	7	16	40.4	55.6	22.2	UCFCX10-31 UCFCX10 UCFCX10-32		UCX10-31 UCX10 UCX10-32	3.2 3.2 3.2	43.4	29.4	14.4	UCFCX10C UCFCX10D	45	1 25/32	3.2																					2																																																																																																																																																																																																																																																																																																																																																																																																																																																																																																																																																																																																																																			
	1 3/4	6 1/2	4.3307	5 7/16	3 27/32	5/8	1 3/32	25/64	15/32	1 11/16	2.031	0.748	UCFCX10-31 UCFCX10 UCFCX10-32	FCX10	UCX10-31 UCX10 UCX10-32	3.2 3.2 3.2	43.4	29.4	14.4	UCFCX10C UCFCX10D	45	1 25/32	3.2																						1 15/16	6 3/8	4.6457	5 23/64	3 25/32	35/64	31/32	9/32	5/8	1 19/32	2.189	0.874																													2	162	118	136	96.2	14	25	7	16	40.4	55.6	22.2	UCFCX10-31 UCFCX10 UCFCX10-32		UCX10-31 UCX10 UCX10-32	3.2 3.2 3.2	43.4	29.4	14.4	UCFCX10C UCFCX10D	45	1 25/32	3.2																					2																																																																																																																																																																																																																																																																																																																																																																																																																																																																																																																																																																																																																																																																																	
	1 15/16	6 3/8	4.6457	5 23/64	3 25/32	35/64	31/32	9/32	5/8	1 19/32	2.189	0.874																													2	162	118	136	96.2	14	25	7	16	40.4	55.6	22.2	UCFCX10-31 UCFCX10 UCFCX10-32		UCX10-31 UCX10 UCX10-32	3.2 3.2 3.2	43.4	29.4	14.4	UCFCX10C UCFCX10D	45	1 25/32	3.2																					2																																																																																																																																																																																																																																																																																																																																																																																																																																																																																																																																																																																																																																																																																																																													
	2	162	118	136	96.2	14	25	7	16	40.4	55.6	22.2	UCFCX10-31 UCFCX10 UCFCX10-32		UCX10-31 UCX10 UCX10-32	3.2 3.2 3.2	43.4	29.4	14.4	UCFCX10C UCFCX10D	45	1 25/32	3.2																					2																																																																																																																																																																																																																																																																																																																																																																																																																																																																																																																																																																																																																																																																																																																																																																					
	2																																																																																																																																																																																																																																																																																																																																																																																																																																																																																																																																																																																																																																																																																																																																																																																																																

Observaciones 1. En los códigos de las unidades y de las unidades con tapas, los códigos de los accesorios siguen los números del diámetro interno.

2. Los códigos de los engrasadores apropiados para cada caso están indicados abajo.

- A-1/4-28UNF 201~210, X05~X09
- A-R1/8..... 211~218, X10~X20

3. Para los artículos con triple sellado (los que van de 201 a 205 tienen doble sellado), el código complementario L3 (o L2) sigue el código de la unidad o del rodamiento. (Ejemplo de código: UCFC206L3, UC206L3)

4. Para las medidas y las formas de los rodamientos apropiados a cada caso, ver las tablas dimensionales de las combinaciones entre rodamientos y soportes.

5. También están disponibles soportes de hierro fundido de estructura nodular.



UCT

Agujero cilíndrico (con tornillos prisioneros)
 d 12 ~ (45) mm

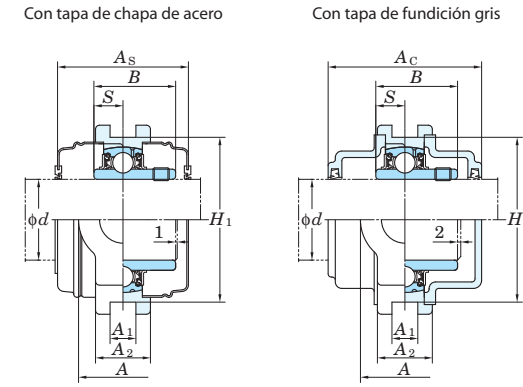
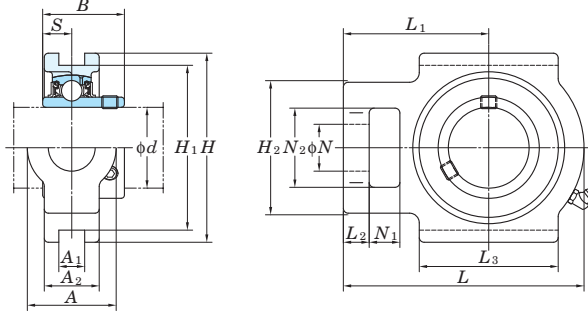

Variaciones en la tolerancia del ancho de las ranuras (ΔA_{1s}), de la distancia entre ambas ranuras (ΔH_{1s}) y de la simetría de ambos lados de las ranuras (X)

Código del Soporte			ΔA_{1s}	ΔH_{1s}	X
T204~T210	TX05~TX10	T305~T310	+0.2 0	0 -0.5	0.5
T211~T217	TX11~TX17	T311~T318	+0.3 0	0 -0.8	0.6
		T319~T322			0.7
		T324~T328			0.8

Las formas y las medidas de L_c para T204/E3 y T205/E3 (soporte con tapa de fundición gris) están indicadas abajo.

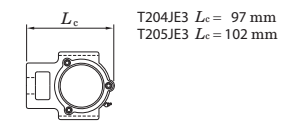

Diámetro del eje mm inch d	Medidas															Estándar			Coeeficientes Básicos de Carga			Factor	Con tapa de chapa de acero				Con tapa de fundición gris																							
	A	A ₁	A ₂	H	H ₁	H ₂	L	L ₁	L ₂	L ₃	N	N ₁	N ₂	B	S	Código Unidad	Código Soporte	Código Rodamiento	Peso	C_r	C_{0r}		kg	Código Unidad Mod. abierto	Código Unidad Mod. cerrado por un lado	Medidas mm	Medidas inch	Peso	kg	Código Unidad Mod. abierto	Código Unidad Mod. cerrado por un lado	Medidas mm	Medidas inch	Peso	kg															
12 1/2																UCT201	T204	UC201	0.81	12.8	6.65	13.2	UCT201C	UCT201CD	45	1 25/32	0.81																							
	15 5/8	1 1/4	15/32	13/16	3 1/2	2 93/64	2	3 11/16	2 13/32	13/32	2	3/4	5/8	1 1/4	1.220								0.500	UCT201-8	UC201-8	0.81																								
17 3/4																UCT202	T204	UC202	0.79	12.8	6.65	13.2	UCT202C	UCT202CD	45	1 25/32	0.79																							
	20	32	12	21	89	76	51	94	61	10	51	19	16	32	31								12.7	UCT202-10	UC202-10	0.79																								
25 1																UCT203	T205	UC203	0.78	14.0	7.85	13.9	UCT203C	UCT203CD	45	1 25/32	0.78																							
	25	32	12	24	89	76	51	97	62	10	51	19	16	32	34.1								14.3	UCT203-12	UC203-12	0.78																								
30 1 1/8																UCT204	T205	UC204	0.76	19.5	11.3	13.9	UCT204C	UCT204CD	45	1 25/32	0.76																							
	30	32	12	24	89	76	51	97	62	10	51	19	16	32	34.1								14.3	UCT204	UC204	0.76																								
35 1 1/4																UCT205	T206	UC205	0.84	25.7	15.4	13.9	UCT205C	UCT205CD	49	1 15/16	0.84																							
	35	32	12	28	102	89	56	113	70	10	57	22	16	37	38.1								15.9	UCT205	UC205	0.84																								
40 1 1/2																UCTX05	T305	UCX05	1.4	33.4	19.3	13.2	UCTX05C	UCTX05CD	53	2 3/32	1.4																							
	40	37	12	28	102	89	56	113	70	10	57	22	16	37	38.1								15.9	UCTX05	UCX05	1.4																								
45 1 1/2																UCT305	T306	UC305	1.4	34.1	21.3	14.0	UCT305C	UCT305CD	76	3	2.0																							
	45	36	12	26	89	80	62	122	76	12	65	26	16	36	38								15	UCT305	UC305	1.4																								

Observaciones 1. En los códigos de las unidades y de las unidades con tapas, los códigos de los accesorios siguen los números del diámetro interno.
 2. Los códigos de los engrasadores apropiados para cada caso están indicados abajo.
 B-1/4-28UNF.....201~210, X05~X09, 305~308
 B-R1/8.....211~217, X10~X17, 309~328

3. Para los artículos con triple sellado (los que van de 201 a 205 tienen doble sellado), el código complementario L3 (o L2) sigue el código de la unidad o del rodamiento. (Ejemplo de código: UCT206JL3, UC206L3)
 4. Para las medidas y las formas de los rodamientos apropiados para cada caso, ver las tablas dimensionales de las combinaciones entre rodamientos y soportes.
 5. También están disponibles soportes de hierro fundido de estructura nodular.



UCT
Agujero cilíndrico (con tornillos prisioneros)
d (75) ~ 140 mm

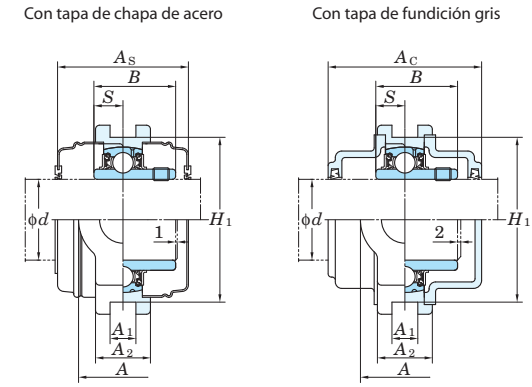
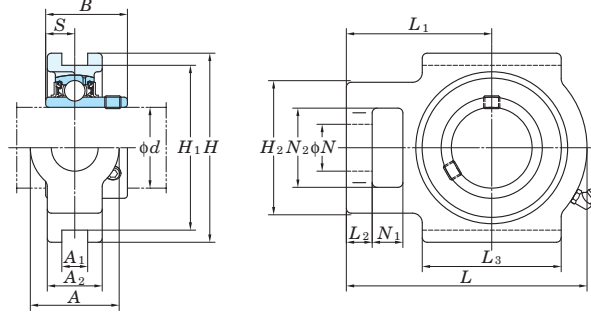

Variaciones en la tolerancia del ancho de las ranuras (ΔA_{1s}), de la distancia entre ambas ranuras (ΔH_{1s}) y de la simetría de ambos lados de las ranuras (X)

Código del Soporte				Unidad: mm	
T204~T210	TX05~TX10	T305~T310	ΔA_{1s}	ΔH_{1s}	X
			+0.2 0	0 -0.5	0.5
T211~T217	TX11~TX17	T311~T318	+0.3 0	0 -0.8	0.6
		T319~T322			0.7
		T324~T328			0.8

Las formas y las medidas de L_c para T204/E3 y T205/E3 (soporte con tapa de fundición gris) están indicadas abajo.

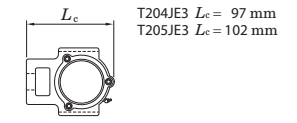

Diámetro del eje mm inch d	Medidas inch mm															Estándar			Coeeficientes Básicos de Carga			Factor	Con tapa de chapa de acero			Con tapa de fundición gris						
	A	A1	A2	H	H1	H2	L	L1	L2	L3	N	N1	N2	B	S	Código Unidad	Código Soporte	Código Rodamiento	Peso	C_r	C_{0r}		Código Unidad Mod. abierto	Código Unidad Mod. cerrado por un lado	Medidas mm inch	Peso	Código Unidad Mod. abierto	Código Unidad Mod. cerrado por un lado	Medidas mm inch	Peso		
75 3	2 3/4	1 7/64	1 7/8	7 1/4	6 1/2	4 3/8	9 1/4	5 1/2	13/16	4 3/4	1 5/8	1 1/4	2 3/4	3.252	1.311	UCTX15-47	TX15	UCX15-47	8.7	72.7	53.0	14.6	UCTX15C	UCTX15CD	109 4 9/32	8.7	—	—	—	—		
	3	28	48	184	165	111	235	140	21	121	41	32	70	82.6	33.3	UCTX15	UCX15	UCX15-48	8.7	—	—	—	—	—	—	—	—	—	—	—		
	3 17/32	1 1/32	2 5/32	8 1/2	7 9/16	5 3/16	10 5/16	6 5/16	3 1/2	5 29/32	1 13/16	1 13/32	3 11/32	3.228	1.260	UCT315-47	T315	UC315-47	13.0	113	77.2	13.2	—	—	—	—	—	—	—	—	—	—
3	90	26	55	216	192	132	262	160	25	150	46	36	85	82	32	UCT315	UC315	UC315-48	13.0	—	—	—	UCT315C	UCT315CD	134 5 9/32	15.5	—	—	—	—	—	
80 —	2 3/4	1 1/32	2	7 1/4	6 1/2	4 3/8	9 1/4	5 1/2	13/16	4 3/4	1 5/8	1 1/4	2 3/4	3.252	1.311	UCT216-50	T216	UC216-50	8.2	72.7	53.0	14.6	—	—	—	—	—	—	—	—	—	
	70	26	51	184	165	111	235	140	21	121	41	32	70	82.6	33.3	UCT216	UC216	UC216	8.2	—	—	—	UCT216C	UCT216CD	109 4 9/32	8.2	UCT216FC	UCT216FCD	138 5 7/16	10.6		
	2 7/8	1 7/64	2 1/8	7 25/32	6 13/16	4 7/8	10 1/4	6 3/8	1 3/32	6 3/16	1 7/8	1 1/2	2 7/8	3.374	1.343	UCTX16	TX16	UCX16	11.7	84.0	61.9	14.5	UCTX16C	UCTX16CD	113 4 7/16	11.7	—	—	—	—	—	
—	73	28	54	198	173	124	260	162	28	157	48	38	73	85.7	34.1	UCT316	T316	UC316	16.2	123	86.7	13.3	—	—	—	—	UCT316C	UCT316CD	138 5 7/16	19.1		
—	4 1/32	1 3/16	2 3/8	9 1/16	8 1/32	5 29/32	11 3/32	6 27/32	1 3/32	6 5/16	2 3/32	1 21/32	3 27/32	3.386	1.339	UCT217-52	T217	UC217-52	11.0	84.0	61.9	14.5	—	—	—	—	—	—	—	—	—	—
85 —	2 7/8	1 7/64	2 1/8	7 25/32	6 13/16	4 7/8	10 1/4	6 3/8	1 3/32	6 3/16	1 7/8	1 1/2	2 7/8	3.374	1.343	UCT217	UC217	UC217	11.0	—	—	—	UCT217C	UCT217CD	113 4 7/16	11.0	UCT217FC	UCT217FCD	142 5 19/32	13.7		
	73	28	54	198	173	124	260	162	28	157	48	38	73	85.7	34.1	UCTX17	TX17	UCX17	11.7	96.1	71.5	14.5	UCTX17C	UCTX17CD	123 4 27/32	11.7	—	—	—	—	—	
	4 1/32	1 17/64	2 17/32	9 7/16	8 27/64	5 31/32	11 23/32	7 7/32	1 3/16	6 11/16	2 3/32	1 21/32	3 27/32	3.780	1.575	UCT317	T317	UC317	19.0	133	96.8	13.3	—	—	—	—	UCT317C	UCT317CD	146 5 3/4	22.3		
—	102	30	60	230	204	150	282	174	28	160	53	42	98	86	34	UCT318-56	T318	UC318-56	21.6	143	107	13.3	—	—	—	—	—	—	—	—	—	
90 —	4 11/32	1 7/64	2 19/32	10 1/32	8 21/32	6 5/16	12 9/32	7 9/16	1 3/16	6 7/8	2 1/4	1 13/16	4 3/16	3.780	1.575	UCT318	UC318	UC318	21.6	—	—	—	—	—	—	—	—	—	—	—	—	
	110	32	66	255	228	160	312	192	30	175	57	46	106	96	40	UCT319	T319	UC319	24.9	153	119	13.3	—	—	—	—	UCT319C	UCT319CD	162 6 3/8	29.2		
	4 11/32	1 3/8	2 27/32	10 5/8	9 29/64	6 1/2	12 11/16	7 3/4	1 7/32	7 3/32	2 1/4	1 13/16	4 3/16	4.055	1.614	UCT320	T320	UC320	30.7	173	141	13.2	—	—	—	—	UCT320C	UCT320CD	174 6 27/32	36.3		
—	110	35	72	270	240	165	322	197	31	180	57	46	106	103	41	UCT320-63	UC320-63	UC320-64	30.7	—	—	—	—	—	—	—	—	—	—	—		
100 —	4 23/32	1 3/8	2 15/16	11 13/32	10 15/64	6 7/8	13 19/32	8 9/32	1 1/4	7 7/8	2 5/16	1 7/8	4 17/32	4.252	1.654	UCT321	T321	UC321	36.7	184	153	13.2	—	—	—	—	UCT321C	UCT321CD	178 7	42.7		
	120	35	75	290	260	175	345	210	32	200	59	48	115	108	42	UCT322	T322	UC322	39.7	205	180	13.2	—	—	—	—	UCT322C	UCT322CD	188 7 13/32	46.5		
	4 23/32	1 3/8	2 15/16	11 13/32	10 15/64	6 7/8	13 19/32	8 9/32	1 1/4	7 7/8	2 5/16	1 7/8	4 17/32	4.409	1.732	UCT324	T324	UC324	54.4	207	185	13.5	—	—	—	—	UCT324C	UCT324CD	196 7 23/32	63.9		
—	120	35	75	290	260	175	345	210	32	200	59	48	115	112	44	UCT326	T326	UC326	69.3	229	214	13.6	—	—	—	—	UCT326C	UCT326CD	214 8 7/16	81.4		
110 —	5 1/8	1 1/2	3 5/32	12 19/32	11 7/32	7 9/32	15 5/32	9 1/4	1 1/2	8 15/32	2 9/16	2 1/16	4 29/32	4.606	1.811	UCT328	T328	UC328	85.1	253	246	13.6	—	—	—	—	UCT328C	UCT328CD	222 8 3/4	101		
	130	38	80	320	285	185	385	235	38	215	65	52	125	117	46	—	—	—	—	—	—	—	—	—	—	—	—	—	—			
	5 1/2	1 49/64	3 17/32	13 31/32	12 9/32	8 9/32	17	10 1/2	1 21/32	9 1/16	2 3/4	2 3/8	5 1/2	4.961	2.008	—	—	—	—	—	—	—	—	—	—	—	—	—	—	—		
—	140	45	90	355	320	210	432	267	42	230	70	60	140	126	51	—	—	—	—	—	—	—	—	—	—	—	—	—	—	—		
120 —	5 29/32	1 31/32	3 15/16	15 5/32	13 25/32	8 21/32	18 5/16	11 7/32	1 25/32	9 7/16	2 15/16	2 9/16	5 29/32	5.315	2.126	—	—	—	—	—	—	—	—	—	—	—	—	—	—	—		
	150	50	100	385	350	220	465	285	45	240	75	65	150	135	54	—	—	—	—	—	—	—	—	—	—	—	—	—	—	—		
	6 3/32	1 31/32	3 15/16	16 11/32	14 61/64	9 1/16	20 9/32	12 13/32	1 31/32	10 1/32	3 5/32	2 3/4	6 5/16	5.709	2.323	—	—	—	—	—	—	—	—	—	—	—	—	—	—	—		
—	155	50	100	415	380	230	515	315	50	255	80	70	160	145	59	—	—	—	—	—	—	—	—	—	—	—	—	—	—	—		

Observaciones 1. En los códigos de las unidades y de las unidades con tapas, los códigos de los accesorios siguen los números del diámetro interno.
2. Los códigos de los engrasadores apropiados para cada caso están indicados abajo.
B-1/4-28UNF.....201~210, X05~X09, 305~308
B-R1/8.....211~217, X10~X17, 309~328

3. Para los artículos con triple sellado (los que van de 201 a 205 tienen doble sellado), el código complementario L3 (o L2) sigue el código de la unidad o del rodamiento. (Ejemplo de código: UCT206JL3, UC206L3)
4. Para las medidas y las formas de los rodamientos apropiados para cada caso, ver las tablas dimensionales de las combinaciones entre rodamientos y soportes.
5. También están disponibles soportes de hierro fundido de estructura nodular.



UCHA
Agujero cilíndrico (con tornillos prisioneros)
d 12 ~ 75 mm

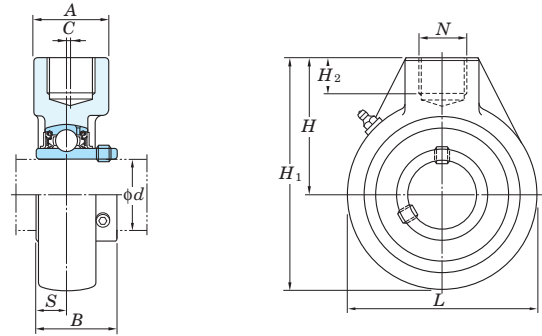

Note 1) Las dimensiones N del agujero del tornillo están acordes al estándar JIS B0203 (Roscas cónicas).
 No se puede aplicar a las Roscas Macho Cilíndricas.
 Abajo, están indicadas las medidas de las Roscas Hembra Cilíndricas.

Unidad: mm

Designación Rosca	Rosca Hembra			Rosca	Rosca Macho compatible
	Diámetro Exterior	Diámetro Medio	Diámetro Interior	Número de Roscas (en 25.4 mm) n	
Rp 3/4	26.441	25.279	24.117	14	R 3/4
Rp 1	33.249	31.770	30.291	11	R 1
Rp 1 1/4	41.910	40.431	38.952	11	R 1 1/4
Rp 1 1/2	47.803	46.324	44.845	11	R 1 1/2

Diámetro del eje mm inch d	Medidas inch mm										Código Unidad	Código Soporte	Código Rodamiento	Coeficientes Básicos de Carga kN		Factor f ₀	Peso kg
	H	A	L	H ₁	H ₂	N ¹⁾	C	B	S	C _r				C _{0r}			
12 1/2											UCHA201 UCHA201-8 UCHA202 UCHA202-10 UCHA203 UCHA204-12 UCHA204	HA204	UC201 UC201-8 UC202 UC202-10 UC203 UC204-12 UC204	12.8	6.65	13.2	0.77 0.75 0.74 0.72
15 5/8	2 17/32	1 9/16	2 17/32	3 25/32	3/4	Rp 3/4	-	1.220	0.500		UCHA205-14 UCHA205-15 UCHA205 UCHA205-16	HA205	UC205-14 UC205-15 UC205 UC205-16	14.0	7.85	13.9	0.87
17 3/4	64	40	64	96	19	Rp 3/4	-	31	12.7		UCHA206-18 UCHA206 UCHA206-19 UCHA206-20	HA206	UC206-18 UC206 UC206-19 UC206-20	19.5	11.3	13.9	0.83
20											UCHA207-20 UCHA207-21 UCHA207-22 UCHA207 UCHA207-23	HA207	UC207-20 UC207-21 UC207-22 UC207 UC207-23	25.7	15.4	13.9	1.2
25 1 1/8	2 17/32	1 9/16	3 1/16	4 1/16	3/4	Rp 3/4	-	1.343	0.563		UCHA208-24 UCHA208-25 UCHA208	HA208	UC208-24 UC208-25 UC208	29.1	17.8	14.0	1.3
30 1 3/16	64	40	78	103	19	Rp 3/4	-	38.1	15.9		UCHA209-26 UCHA209-27 UCHA209-28 UCHA209	HA209	UC209-26 UC209-27 UC209-28 UC209	34.1	21.3	14.0	1.7
35 1 1/4	2 3/4	1 9/16	3 5/8	4 9/16	3/4	Rp 3/4	-	1.689	0.689		UCHA210-30 UCHA210-31 UCHA210 UCHA210-32	HA210	UC210-30 UC210-31 UC210 UC210-32	35.1	23.3	14.4	2.1
40 1 1/2	2 7/8	1 9/16	3 25/32	4 3/4	3/4	Rp 3/4	5/64	1.937	0.748		UCHA211-32 UCHA211-34 UCHA211 UCHA211-35	HA211	UC211-32 UC211-34 UC211 UC211-35	43.4	29.4	14.4	2.8
45 1 5/8	3 7/32	1 7/8	4 1/4	5 11/32	13/16	Rp 1	13/64	1.937	0.748		UCHA212-36 UCHA212 UCHA212-38 UCHA212-39	HA212	UC212-36 UC212 UC212-38 UC212-39	52.4	36.2	14.4	3.9
50 1 15/16	3 9/32	1 7/8	4 21/32	5 19/32	13/16	Rp 1	13/64	2.031	0.748		UCHA213-40 UCHA213	HA213	UC213-40 UC213	57.2	40.1	14.4	5.8
55 2	3 7/16	2 3/8	4 31/32	5 29/32	31/32	Rp 1 1/4	9/32	2.189	0.874		UCHA214-44 UCHA214	HA214	UC214-44 UC214	62.2	44.1	14.5	5.9
60 2 3/8	4 1/32	2 3/8	5 19/32	6 13/16	1 3/32	Rp 1 1/4	23/64	2.563	1.000		UCHA215-47 UCHA215 UCHA215-48	HA215	UC215-47 UC215 UC215-48	67.4	48.3	14.5	5.6
65 2 7/16	4 19/32	2 3/4	6 17/32	7 7/8	1 1/4	Rp 1 1/2	3/8	2.563	1.000								
70 2 3/4	4 19/32	2 3/4	6 17/32	7 7/8	1 1/4	Rp 1 1/2	3/8	2.937	1.189								
75 2 15/16	4 19/32	2 3/4	6 17/32	7 7/8	1 1/4	Rp 1 1/2	3/8	3.063	1.311								

Observaciones 1. En los códigos de las unidades y de las unidades con tapas, los códigos de los accesorios siguen los números del diámetro interno.
 2. Los códigos de los engrasadores apropiados para cada caso están indicados abajo.
 A-1/4-28UNF 201~210
 A-R1/8..... 211~215

3. Para los artículos con triple sellado (los que van de 201 a 205 tienen doble sellado), el código complementario L3 (o L2) sigue el código de la unidad o del rodamiento. (Ejemplo de código: UCHA206JL3, UC206L3)
 4. Para las medidas y las formas de los rodamientos apropiados para cada caso, ver las tablas dimensionales de las combinaciones entre rodamientos y soportes.
 5. También están disponibles modelos con agujero cónico (con manguito). (Ejemplo de código: UKHA205J + H2305X, UK205+H2305X)



UC, SB, SU
Agujero cilíndrico (con tornillos prisioneros)
d 8 ~ (35) mm

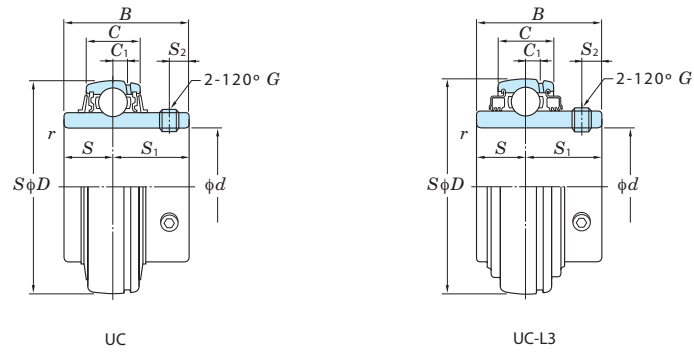

d (35) ~ (80) mm

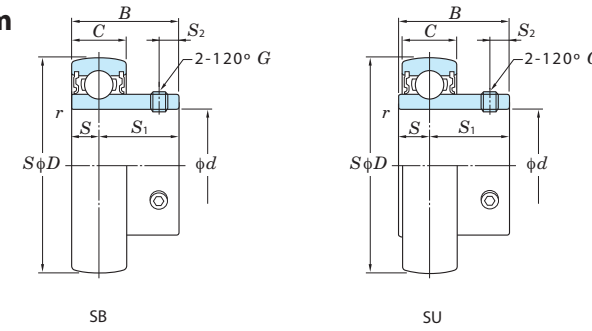

Diámetro del eje mm	Medidas mm				Coeficientes Básicos de Carga kN		Factor f ₀	Código Rodamiento		Medidas mm				Agujero Tornillo Prisionero mm	Peso kg
	d	D	B	C	r (min.)	C _r		C _{0r}	Estándar	Mod. L3	C ₁	S	S ₁		
8	22	12	7	0.3	3.27	1.37	12.4	SU08	-	-	3.5	8.5	2.8	M3x0.35	0.012
10	26	15	8	0.3	4.55	1.95	12.3	SU000	-	-	5	10	3	M3x0.35	0.024
12	28	15	8	0.3	5.10	2.40	13.2	SU001	-	-	5	10	3	M3x0.35	0.026
	40	22	12	0.6	9.55	4.80	13.2	SB201	-	-	6	16	4	M5x0.5	0.10
	47	31	16	0.6	12.8	6.65	13.2	UC201	UC201L2	4	12.7	18.3	5	M6x0.75	0.21
15	32	16.5	9	0.3	5.60	2.85	13.9	SU002	-	-	5.5	11	3.3	M4x0.5	0.038
	40	22	12	0.6	9.55	4.80	13.2	SB202	-	-	6	16	4	M5x0.5	0.10
	47	31	16	0.6	12.8	6.65	13.2	UC202	UC202L2	4	12.7	18.3	5	M6x0.75	0.19
17	35	17.5	10	0.3	6.00	3.25	14.4	SU003	-	-	6	11.5	3.3	M4x0.5	0.050
	40	22	12	0.6	9.55	4.80	13.2	SB203	-	-	6	16	4	M5x0.5	0.10
	47	31	16	0.6	12.8	6.65	13.2	UC203	UC203L2	4	12.7	18.3	5	M6x0.75	0.18
20	42	21	12	0.6	9.40	5.05	13.9	SU004	-	-	7	14	4	M5x0.5	0.080
	47	25	14	1	12.8	6.65	13.2	SB204	-	-	7	18	5	M6x0.75	0.15
	47	31	16	1	12.8	6.65	13.2	UC204	UC204L2	4	12.7	18.3	5	M6x0.75	0.16
25	47	22	12	0.6	10.1	5.85	14.5	SU005	-	-	7	15	4.5	M5x0.5	0.10
	52	27	15	1	14.0	7.85	13.9	SB205	-	-	7.5	19.5	5.5	M6x0.75	0.18
	52	34.1	17	1	14.0	7.85	13.9	UC205	UC205L2	5	14.3	19.8	5.5	M6x0.75	0.20
	62	38	22	1.1	21.2	10.9	12.6	UC305	-	6	15	23	6	M6x0.75	0.45
	62	38.1	19	1	19.5	11.3	13.9	UCX05	UCX05L3	5	15.9	22.2	6	M6x0.75	0.39
30	55	24.5	13	1	13.2	8.25	14.7	SU006	-	-	7.5	17	5.5	M5x0.5	0.15
	62	30	16	1	19.5	11.3	13.9	SB206	-	-	8	22	6	M6x0.75	0.27
	62	38.1	19	1	19.5	11.3	13.9	UC206	UC206L3	5	15.9	22.2	6	M6x0.75	0.32
	72	42.9	20	1	25.7	15.4	13.9	UCX06	UCX06L3	5.5	17.5	25.4	6.5	M8x1	0.58
	72	43	24	1.1	26.7	15.0	13.3	UC306	-	6.5	17	26	6	M6x0.75	0.56
35	72	32	17	1.1	25.7	15.4	13.9	SB207	-	-	8.5	23.5	6	M6x0.75	0.42
	72	42.9	20	1.1	25.7	15.4	13.9	UC207	UC207L3	5.5	17.5	25.4	6.5	M8x1	0.48
	80	49.2	21	1.1	29.1	17.8	14.0	UCX07	UCX07L3	6	19	30.2	8	M8x1	0.75

Observaciones 1. El modelo de rodamiento SU pertenece a la Serie Limpia.
 2. Los artículos que van de UC201 a 205 tienen doble sellado (L2).

Diámetro del eje mm	Medidas mm				Coeficientes Básicos de Carga kN		Factor f ₀	Código Rodamiento		Medidas mm				Agujero Tornillo Prisionero mm	Peso kg
	d	D	B	C	r (min.)	C _r		C _{0r}	Estándar	Mod. L3	C ₁	S	S ₁		
35	80	48	26	1.5	33.4	19.3	13.2	UC307	UC307L3	7.5	19	29	8	M8x1	0.71
40	80	34	18	1.1	29.1	17.8	14.0	SB208	-	-	9	25	8	M8x1	0.60
	80	49.2	21	1.1	29.1	17.8	14.0	UC208	UC208L3	6	19	30.2	8	M8x1	0.64
	85	49.2	22	1.1	34.1	21.3	14.0	UCX08	UCX08L3	6	19	30.2	8	M8x1	0.83
	90	52	28	1.5	40.7	24.0	13.2	UC308	UC308L3	8	19	33	10	M10x1.25	1.00
45	85	49.2	22	1.1	34.1	21.3	14.0	UC209	UC209L3	6	19	30.2	8	M8x1	0.68
	90	51.6	24	1.1	35.1	23.3	14.4	UCX09	UCX09L3	6	19	32.6	9	M10x1.25	0.95
	100	57	30	1.5	48.9	29.5	13.3	UC309	UC309L3	8.5	22	35	10	M10x1.25	1.33
50	90	51.6	24	1.1	35.1	23.3	14.4	UC210	UC210L3	6	19	32.6	9	M10x1.25	0.80
	100	55.6	25	1.1	43.4	29.4	14.4	UCX10	UCX10L3	7	22.2	33.4	9	M10x1.25	1.29
	110	61	32	2	62.0	38.3	13.2	UC310	UC310L3	9	22	39	12	M12x1.5	1.69
55	100	55.6	25	1.5	43.4	29.4	14.4	UC211	UC211L3	7	22.2	33.4	9	M10x1.25	1.11
	110	65.1	27	1.5	52.4	36.2	14.4	UCX11	UCX11L3	7.5	25.4	39.7	10.5	M10x1.25	1.80
	120	66	34	2	71.6	45.0	13.2	UC311	UC311L3	10	25	41	12	M12x1.5	1.90
60	110	65.1	27	1.5	52.4	36.2	14.4	UC212	UC212L3	7.5	25.4	39.7	10.5	M10x1.25	1.54
	120	65.1	28	1.5	57.2	40.1	14.4	UCX12	UCX12L3	7.5	25.4	39.7	12	M12x1.5	2.05
	130	71	36	2.1	81.9	52.2	13.2	UC312	UC312L3	11.5	26	45	12	M12x1.5	2.60
65	120	65.1	28	1.5	57.2	40.1	14.4	UC213	UC213L3	7.5	25.4	39.7	12	M12x1.5	1.86
	125	74.6	30	1.5	62.2	44.1	14.5	UCX13	UCX13L3	9	30.2	44.4	12	M12x1.5	2.52
	140	75	38	2.1	92.7	59.9	13.2	UC313	UC313L3	12	30	45	12	M12x1.5	3.16
70	125	74.6	30	1.5	62.2	44.1	14.5	UC214	UC214L3	9	30.2	44.4	12	M12x1.5	2.05
	130	77.8	32	1.5	67.4	48.3	14.5	UCX14	UCX14L3	9	33.3	44.5	12	M12x1.5	2.74
	150	78	40	2.1	104	68.2	13.2	UC314	UC314L3	12.5	33	45	12	M12x1.5	3.90
75	130	77.8	32	1.5	67.4	48.3	14.5	UC215	UC215L3	9	33.3	44.5	12	M12x1.5	2.21
	140	82.6	33	1.5	72.7	53.0	14.6	UCX15	UCX15L3	9	33.3	49.3	14	M12x1.5	3.41
	160	82	42	2.1	113	77.2	13.2	UC315	UC315L3	14.5	32	50	14	M14x1.5	4.70
80	140	82.6	33	2	72.7	53.0	14.6	UC216	UC216L3	9	33.3	49.3	14	M12x1.5	2.79



UC, SB, SU
Agujero cilíndrico (con tornillos prisioneros)
d (80) ~ 140 mm

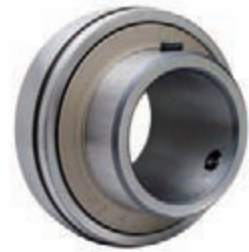

UC

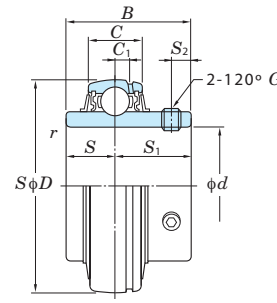

UC

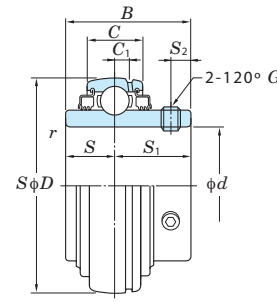

UC-L3

Diámetro del eje mm	Medidas mm				Coeficientes Básicos de Carga kN		Factor f_0	Código Rodamiento		Medidas mm				Agujero Tornillo Prisionero mm G	Peso kg
	d	D	B	C	r (min.)	C_r		C_{or}	Estándar	Mod. L3	C_1	S	S_1		
80	150	85.7	35	2	84.0	61.9	14.5	UCX16	UCX16L3	10	34.1	51.6	14	M12×1.5	3.87
	170	86	44	2.1	123	86.7	13.3	UC316	UC316L3	15	34	52	14	M14×1.5	5.60
85	150	85.7	35	2	84.0	61.9	14.5	UC217	UC217L3	10	34.1	51.6	14	M12×1.5	3.45
	160	96	38	2	96.1	71.5	14.5	UCX17	UCX17L3	11	39.7	56.3	15	M12×1.5	5.05
	180	96	46	3	133	96.8	13.3	UC317	UC317L3	15	40	56	16	M16×1.5	6.90
90	160	96	38	2	96.1	71.5	14.5	UC218	UC218L3	11	39.7	56.3	15	M12×1.5	4.35
	170	104	40	2	109	81.9	14.4	UCX18	-	11.5	42.9	61.1	16	M14×1.5	6.00
	190	96	48	3	143	107	13.3	UC318	UC318L3	15.5	40	56	16	M16×1.5	7.87
95	200	103	50	3	153	119	13.3	UC319	UC319L3	16.5	41	62	18	M16×1.5	8.91
100	190	117.5	43	2.1	133	105	14.4	UCX20	-	13	49.2	68.3	18	M16×1.5	8.56
	215	108	54	3	173	141	13.2	UC320	UC320L3	18	42	66	20	M18×1.5	11.2
105	225	112	56	3	184	153	13.2	UC321	-	19	44	68	20	M18×1.5	12.7
110	240	117	60	3	205	180	13.2	UC322	UC322L3	20	46	71	20	M18×1.5	15.1
120	260	126	64	3	207	185	13.5	UC324	UC324L3	21	51	75	20	M18×1.5	19.0
130	280	135	68	4	229	214	13.6	UC326	UC326L3	22	54	81	20	M20×1.5	23.6
140	300	145	72	4	253	246	13.6	UC328	UC328L3	23	59	86	20	M20×1.5	29.4

Observaciones 1. El modelo de rodamiento SU pertenece a la Serie Limpia.

NA
Agujero cilíndrico
(con anillo de fijación excéntrico)
d 12 ~ 75 mm

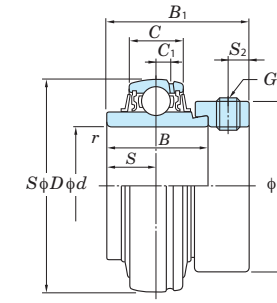

NA

Diámetro del eje mm	Medidas mm					Coeficientes Básicos de Carga kN		Factor f_0	Código Rodamiento	Medidas mm				Agujero Tornillo Prisionero mm G	Peso kg
	d	D	B	B_1	C	r (min.)	C_r			C_{or}	C_1	S	S_2		
12	47	34.2	43.7	16	1	12.8	6.65	13.2	NA201	4	17.1	4.8	33.3	M6×0.75	0.29
15	47	34.2	43.7	16	1	12.8	6.65	13.2	NA202	4	17.1	4.8	33.3	M6×0.75	0.27
17	47	34.2	43.7	16	1	12.8	6.65	13.2	NA203	4	17.1	4.8	33.3	M6×0.75	0.25
20	47	34.2	43.7	16	1	12.8	6.65	13.2	NA204	4	17.1	4.8	33.3	M6×0.75	0.22
25	52	34.9	44.4	17	1	14.0	7.85	13.9	NA205	5	17.5	4.8	38.1	M6×0.75	0.25
30	62	36.5	48.4	19	1	19.5	11.3	13.9	NA206	5	18.3	6	44.5	M8×1	0.41
35	72	37.6	51.1	20	1.1	25.7	15.4	13.9	NA207	5.5	18.8	6.8	55.6	M8×1	0.61
40	80	42.8	56.3	21	1.1	29.1	17.8	14.0	NA208	6	21.4	6.8	60.3	M8×1	0.78
45	85	42.8	56.3	22	1.1	34.1	21.3	14.0	NA209	6	21.4	6.8	63.5	M8×1	0.85
50	90	49.2	62.7	24	1.1	35.1	23.3	14.4	NA210	6	24.6	6.8	69.9	M8×1	1.01
55	100	55.5	71.4	25	1.5	43.4	29.4	14.4	NA211	7	27.8	8	76.2	M10×1.25	1.39
60	110	61.9	77.8	27	1.5	52.4	36.2	14.4	NA212	7.5	31	8	84.2	M10×1.25	1.87
65	120	68.2	85.7	28	1.5	57.2	40.1	14.4	NA213	7.5	34.1	8.5	92	M10×1.25	2.45
70	125	68.2	85.7	30	1.5	62.2	44.1	14.5	NA214	9	34.1	8.5	97	M10×1.25	2.92
75	130	74.6	92.1	32	1.5	67.4	48.3	14.5	NA215	9	37.3	8.5	102	M10×1.25	2.74



UK

Agujero cónico (con manguito adaptador)
 d_1 20 ~ 60 mm



UK



UK+H

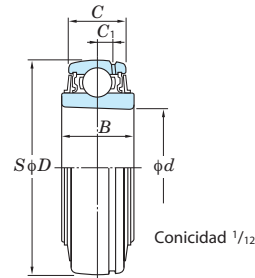

UK

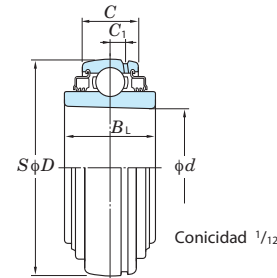

UK-L3

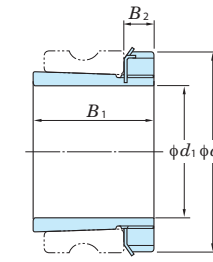

Adaptador

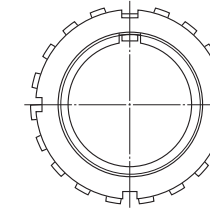

Diámetro del eje mm d_1	Medidas mm					Coeficientes Básicos de Carga kN				Factor f_0	Código Rodamiento		Peso kg		Manguito Adaptador Serie H3					Manguito Adaptador Serie H23					
	d	D	B	B_L	C	C_1	C_r	C_{or}	Estándar		Mod. L3	Estándar	Mod. L3	Código Adaptador	Medidas mm			Peso kg	Código Manguito	Código Adaptador	Medidas mm			Peso kg	Código Manguito
	B_1	B_2	d_2	B_1	B_2	d_2																			
20	25	52	21	24	17	5	14.0	7.85	13.9	UK205	UK205L2	0.16	0.18	H305X	29	8	38	0.075	A305X	H2305X	35	8	38	0.095	A2305X
	25	62	23	-	19	5	19.5	11.3	13.9	UKX05	-	0.27	-	-	-	-	-	-	-	H2305X	35	8	38	0.095	A2305X
	25	62	27	-	22	6	21.2	10.9	12.6	UK305	-	0.40	-	-	-	-	-	-	-	H2305X	35	8	38	0.095	A2305X
25	30	62	23	27	19	5	19.5	11.3	13.9	UK206	UK206L3	0.25	0.29	H306X	31	8	45	0.11	A306X	H2306X	38	8	45	0.13	A2306X
	30	72	26	-	20	5.5	25.7	15.4	13.9	UKX06	-	0.43	-	-	-	-	-	-	-	H2306X	38	8	45	0.13	A2306X
	30	72	30	-	24	6.5	26.7	15.0	13.3	UK306	-	0.47	-	-	-	-	-	-	-	H2306X	38	8	45	0.13	A2306X
30	35	72	26	30	20	5.5	25.7	15.4	13.9	UK207	UK207L3	0.37	0.43	H307X	35	9	52	0.14	A307X	H2307X	43	9	52	0.17	A2307X
	35	80	27	-	21	6	29.1	17.8	14.0	UKX07	-	0.53	-	-	-	-	-	-	-	H2307X	43	9	52	0.17	A2307X
	35	80	33	33	26	7.5	33.4	19.3	13.2	UK307	UK307L3	0.60	-	-	-	-	-	-	-	H2307X	43	9	52	0.17	A2307X
35	40	80	27	34	21	6	29.1	17.8	14.0	UK208	UK208L3	0.47	0.58	H308X	36	10	58	0.19	A308X	H2308X	46	10	58	0.22	A2308X
	40	85	29	-	22	6	34.1	21.3	14.0	UKX08	-	0.58	-	-	-	-	-	-	-	H2308X	46	10	58	0.22	A2308X
	40	90	35	35	28	8	40.7	24.0	13.2	UK308	UK308L3	0.80	-	-	-	-	-	-	-	H2308X	46	10	58	0.22	A2308X
40	45	85	29	36	22	6	34.1	21.3	14.0	UK209	UK209L3	0.52	0.65	H309X	39	11	65	0.25	A309X	H2309X	50	11	65	0.28	A2309X
	45	90	29	-	24	6	35.1	23.3	14.4	UKX09	-	0.67	-	-	-	-	-	-	-	H2309X	50	11	65	0.28	A2309X
	45	100	38	38	30	8.5	48.9	29.5	13.3	UK309	UK309L3	1.08	-	-	-	-	-	-	-	H2309X	50	11	65	0.28	A2309X
45	50	90	29	36	24	6	35.1	23.3	14.4	UK210	UK210L3	0.59	0.65	H310X	42	12	70	0.30	A310X	H2310X	55	12	70	0.36	A2310X
	50	100	31	-	25	7	43.4	29.4	14.4	UKX10	-	0.89	-	-	-	-	-	-	-	H2310X	55	12	70	0.36	A2310X
	50	110	40	40	32	9	62.0	38.3	13.2	UK310	UK310L3	1.38	-	-	-	-	-	-	-	H2310X	55	12	70	0.36	A2310X
50	55	100	31	40	25	7	43.4	29.4	14.4	UK211	UK211L3	0.80	1.09	H311X	45	12	75	0.35	A311X	H2311X	59	12	75	0.42	A2311X
	55	110	33	-	27	7.5	52.4	36.2	14.4	UKX11	-	1.15	-	-	-	-	-	-	-	H2311X	59	12	75	0.42	A2311X
	55	120	43	43	34	10	71.6	45.0	13.2	UK311	UK311L3	1.78	-	-	-	-	-	-	-	H2311X	59	12	75	0.42	A2311X
55	60	110	33	47	27	7.5	52.4	36.2	14.4	UK212	UK212L3	1.02	1.41	H312X	47	13	80	0.43	A312X	H2312X	62	13	80	0.48	A2312X
	60	120	36	-	28	7.5	57.2	40.1	14.4	UKX12	-	1.45	-	-	-	-	-	-	-	H2312X	62	13	80	0.48	A2312X
	60	130	47	47	36	11.5	81.9	52.2	13.2	UK312	UK312L3	2.06	-	-	-	-	-	-	-	H2312X	62	13	80	0.48	A2312X
60	65	120	36	47	28	7.5	57.2	40.1	14.4	UK213	UK213L3	1.34	1.67	H313X	50	14	85	0.46	A313X	H2313X	65	14	85	0.56	A2313X
	65	125	40	-	30	9	62.2	44.1	14.5	UKX13	-	1.62	-	-	-	-	-	-	-	H2313X	65	14	85	0.56	A2313X
	65	140	49	49	38	12	92.7	59.9	13.2	UK313	UK313L3	2.71	-	-	-	-	-	-	-	H2313X	65	14	85	0.56	A2313X

Observaciones 1. En los códigos de las unidades con adaptadores, el código de los adaptadores compatibles sigue el código indicado en las tablas dimensionales. (Ejemplo de código: UK206 + 306X, UK206L3 + H2306X)

2. Series de adaptadores aplicables a la serie UK200

UK200serie H300X

UK200L3 (o L2)serie H2300X

3. UK205 es el modelo con doble sellado (L2).

4. También están disponibles adaptadores con las medidas del diámetro interior en pulgadas (ver las tablas dimensionales de los adaptadores).



UK

Agujero cónico (con manguito adaptador)

d_1 65 ~ 125 mm



UK



UK+H

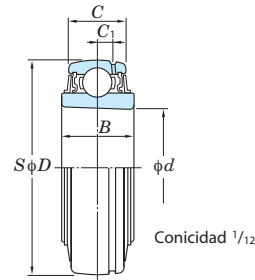

UK

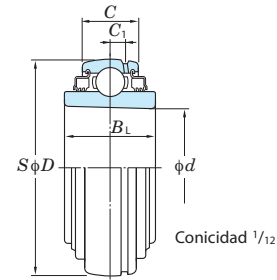

UK-L3

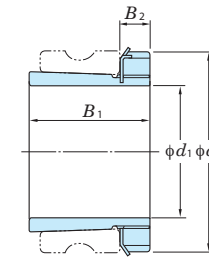

Adaptador

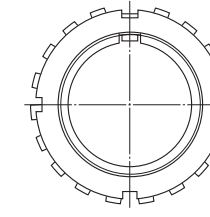









Diámetro del eje mm	Medidas mm									Códigos Rodamiento	Peso kg		Manguito Adaptador Serie H3					Manguito Adaptador Serie H23							
	d	D	B	B _L	C	C ₁	C _r	C _{or}	f ₀		Estándar	Mod. L3	Estándar	Mod. L3	Código Adaptador	Medidas mm	Peso	Código Manguito	Código Adaptador	Medidas mm	Peso	Código Manguito			
d ₁														B ₁	B ₂	d ₂		B ₁	B ₂	d ₂					
65	75	130	40	51	32	9	67.4	48.3	14.5	UK215	UK215L3	1.50	1.99	H315X	55	15	98	0.83	A315X	H2315X	73	15	98	1.05	A2315X
	75	140	42	-	33	9	72.7	53.0	14.6	UKX15	-	2.10	-	-	-	-	-	-	-	H2315X	73	15	98	1.05	A2315X
	75	160	55	55	42	14.5	113	77.2	13.2	UK315	UK315L3	3.80	-	-	-	-	-	-	-	H2315X	73	15	98	1.05	A2315X
70	80	140	42	55	33	9	72.7	53.0	14.6	UK216	UK216L3	1.96	2.56	H316X	59	17	105	1.05	A316X	H2316X	78	17	105	1.3	A2316X
	80	150	44	-	35	10	84.0	61.9	14.5	UKX16	-	2.64	-	-	-	-	-	-	-	H2316X	78	17	105	1.3	A2316X
	80	170	55	55	44	15	123	86.7	13.3	UK316	UK316L3	4.39	-	-	-	-	-	-	-	H2316X	78	17	105	1.3	A2316X
75	85	150	44	57	35	10	84.0	61.9	14.5	UK217	UK217L3	2.42	3.10	H317X	63	18	110	1.2	A317X	H2317X	82	18	110	1.45	A2317X
	85	160	48	-	38	11	96.1	71.5	14.5	UKX17	-	3.25	-	-	-	-	-	-	-	H2317X	82	18	110	1.45	A2317X
	85	180	60	60	46	15	133	96.8	13.3	UK317	UK317L3	5.30	-	-	-	-	-	-	-	H2317X	82	18	110	1.45	A2317X
80	90	160	48	63	38	11	96.1	71.5	14.5	UK218	UK218L3	2.90	3.77	H318X	65	18	120	1.4	A318X	H2318X	86	18	120	1.7	A2318X
	90	170	50	-	40	11.5	109	81.9	14.4	UKX18	-	3.80	-	-	-	-	-	-	-	H2318X	86	18	120	1.7	A2318X
	90	190	60	60	48	15.5	143	107	13.3	UK318	UK318L3	6.20	-	-	-	-	-	-	-	H2318X	86	18	120	1.7	A2318X
85	95	200	66	66	50	16.5	153	119	13.3	UK319	UK319L3	7.31	-	-	-	-	-	-	-	H2319X	90	19	125	1.95	A2319X
90	100	190	54	-	43	13	133	105	14.4	UKX20	-	5.36	-	-	-	-	-	-	-	H2320X	97	20	130	2.2	A2320X
	100	215	68	68	54	18	173	141	13.2	UK320	UK320L3	8.70	-	-	-	-	-	-	-	H2320X	97	20	130	2.2	A2320X
100	110	240	78	78	60	20	205	180	13.2	UK322	UK322L3	12.2	-	-	-	-	-	-	-	H2322X	105	21	145	2.75	A2322X
110	120	260	87	87	64	21	207	185	13.5	UK324	UK324L3	16.1	-	-	-	-	-	-	-	H2324	112	22	155	3.2	A2324
115	130	280	87	87	68	22	229	214	13.6	UK326	UK326L3	18.8	-	-	-	-	-	-	-	H2326	121	23	165	4.6	A2326
125	140	300	97	97	72	23	253	246	13.6	UK328	UK328L3	23.9	-	-	-	-	-	-	-	H2328	131	24	180	5.5	A2328

Observaciones 1. En los códigos de las unidades con adaptadores, el código de los adaptadores compatibles sigue el código indicado en las tablas dimensionales. (Ejemplo de código: UK206 + 306X, UK206L3 + H2306X)

- Series de adaptadores aplicables a la serie UK200
UK200 serie H300X
UK200L3 (o L2) serie H2300X
- UK205 es el modelo con doble sellado (L2).
- También están disponibles adaptadores con las medidas del diámetro interior en pulgadas (ver las tablas dimensionales de los adaptadores).



Apéndice Tabla simplificada de las combinaciones soporte-rodamiento

Tipología	Soporte	Insertos de rodamientos					NA200
		Agujero cilíndrico (con tornillos prisioneros)			Agujero cilíndrico (con anillo excéntrico)		
		UC200	UCX00	UC300	Acero inoxidable UC200S6		
De apoyo 	P200, PX00, P300 P200H4, PX00H4, P300H4	UCP200 UCP200H4	UCPX00 UCPX00H4	UCP300 UCP300H4		NAP200	
	IP200, IP300	UCIP200		UCIP300			
	PA200	UCPA200					
	PH200	UCPH200					
	LP200						
	SP200H1 SPA200H1 VP200 P000, SP000 PP200				UCSP200H1S6 UCSPA200H1S6 UCVP200S6		
	Brida con 4 agujeros 	F200, FX00, F300 F200H4, FX00H4, F300H4	UCF200 UCF200H4	UCFX00 UCFX00H4	UCF300 UCF300H4		NAF200
		FS300 FS300H4			UCFS300 UCFS300H4		
		SF200H1 VF200				UCSF200H1S6 UCVF200S6	
		Brida ovalado 	FL200, FLX00, FL300 FL200H4, FLX00H4, FL300H4	UCFL200 UCFL200H4	UCFLX00 UCFLX00H4	UCFL300 UCFL300H4	
LF200							
FL000, SFL000 SFL200H1 VFL200 PFL200					UCSFL200H1S6 UCVFL200S6		
FA200	UCFA200						
FB200	UCFB200						
Cartucho redondo 	FC200, FCX00 FC200H4, FCX00H4 SFC 200H1		UCFC200 UCFC200H4	UCFCX00 UCFCX00H4		UCSFC200H1S6	NAFC200
	Brida de chapa de acero 	PF200					
Tensor 		T200, TX00, T300 T200H4, TX00H4, T300H4	UCT200 UCT200H4	UCTX00 UCTX00H4	UCT300 UCT300H4		NAT200
	ST200H1				UCST200H1S6		
Cartucho 	C200, CX00, C300	UCC200	UCCX00	UCC300		NAC200	
Colgante 	HA200	UCHA200					

Insertos de rodamientos							
Agujero cónico (con manguito)			Agujero cilíndrico (NU-LOC)	Agujero cilíndrico (con tornillos prisioneros)			
							
UK200	UKX00	UK300	NC200	SU000	Acero inoxidable SU000S6	SB200	
UKP200 UKP200H4	UKPX00 UKPX00H4	UKP300 UKP300H4	NCP200				
UKIP200		UKIP300					
UKPA200			NCPA200				
UKPH200			NCPH200				
							BLP200
				UP000	USP000S6		SBPP200
UKF200 UKF200H4	UKFX00 UKFX00H4	UKF300 UKF300H4	NCF200				
		UKFS300 UKFS300H4					
UKFL200 UKFL200H4	UKFLX00 UKFLX00H4	UKFL300 UKFL300H4	NCFL200				
							BLF205
				UFL000	USFL000S6		SBPFL200
UKFA200			NCFA200				
UKFB200			NCFB200				
UKFC200 UKFC200H4	UKFCX00 UKFCX00H4		NCFC200				
							SBPF200
UKT200 UKT200H4	UKTX00 UKTX00H4	UKT300 UKT300H4	NCT200				
UKC200	UKCX00	UKC300	NCC200				
UKHA200			NCHA200				



Apéndice: Tabla Carga Radial / Velocidad

Carga Normal

Unidad : kN

TAMAÑO DEL EJE	L ₁₀ horas	Carga Radial permitida (kN) a diferentes RPM																				
		RPM (min ⁻¹)																				
		50	100	150	300	500	750	1000	1500	2000	2500	3000	3500	4000	4500	5000	5500	6000	6500	7000	7500	8000
1/2"	10000	4.1	3.2	2.8	2.2	1.9	1.6	1.5	1.3	1.2	1.1	1	1	0.9	0.9	0.8	0.8	0.8	0.7	0.7	0.7	0.7
5/8"	25000	3	2.4	2.1	1.6	1.4	1.2	1.1	0.9	0.8	0.8	0.7	0.7	0.7	0.6	0.6	0.6	0.6	0.5	0.5	0.5	0.5
3/4"	50000	2.4	1.9	1.6	1.3	1.1	0.9	0.8	0.7	0.7	0.6	0.6	0.5	0.5	0.5	0.5	0.4	0.4	0.4	0.4	0.4	0.4
12 mm-20 mm	70000	2.1	1.7	1.4	1.1	1	0.8	0.7	0.6	0.6	0.5	0.5	0.4	0.4	0.4	0.4	0.4	0.4	0.4	0.4	0.3	0.3
	100000	1.9	1.5	1.3	1	0.8	0.7	0.7	0.6	0.5	0.5	0.4	0.4	0.4	0.4	0.4	0.3	0.3	0.3	0.3	0.3	0.3
7/8"	10000	4.5	3.5	3.1	2.4	2	1.8	1.6	1.4	1.3	1.2	1.1	1	1	0.9	0.9	0.9	0.8	0.8	0.8		
15/16"	25000	3.3	2.6	2.3	1.8	1.5	1.3	1.2	1	0.9	0.9	0.8	0.8	0.7	0.7	0.7	0.6	0.6	0.6	0.6	0.6	0.6
1"	50000	2.6	2	1.8	1.4	1.2	1	0.9	0.8	0.7	0.7	0.6	0.6	0.6	0.5	0.5	0.5	0.5	0.5	0.5	0.4	0.4
25 mm	70000	2.3	1.8	1.6	1.2	1	0.9	0.8	0.7	0.6	0.6	0.6	0.5	0.5	0.5	0.5	0.4	0.4	0.4	0.4	0.4	0.4
	100000	2	1.6	1.4	1.1	0.9	0.8	0.7	0.6	0.6	0.5	0.5	0.5	0.4	0.4	0.4	0.4	0.4	0.4	0.4	0.3	0.3
1-1/8"	10000	6.2	4.9	4.3	3.4	2.9	2.5	2.3	2	1.8	1.7	1.6	1.5	1.4	1.3	1.3	1.2					
1-3/16"	25000	4.6	3.6	3.2	2.5	2.1	1.8	1.7	1.4	1.3	1.2	1.1	1.1	1	0.9	0.9	0.9					
1-1/4"	50000	3.6	2.9	2.5	2	1.7	1.4	1.3	1.1	1	0.9	0.9	0.8	0.8	0.7	0.7	0.7					
30 mm	70000	3.2	2.6	2.2	1.8	1.5	1.3	1.2	1	0.9	0.8	0.8	0.7	0.7	0.7	0.6	0.6					
	100000	2.9	2.3	2	1.6	1.3	1.1	1	0.9	0.8	0.7	0.7	0.6	0.6	0.6	0.5						
1-1/4"	10000	8.2	6.5	5.7	4.5	3.8	3.3	3	2.6	2.4	2.2	2.1	2	1.9	1.8	1.7	1.7					
1-5/16"	25000	6	4.8	4.2	3.3	2.8	2.4	2.2	1.9	1.7	1.6	1.5	1.4	1.4	1.3	1.3	1.2					
1-3/8"	50000	4.8	3.8	3.3	2.6	2.2	1.9	1.7	1.5	1.4	1.3	1.2	1.1	1.1	1	1	1					
1-7/16"	70000	4.3	3.4	3	2.3	2	1.7	1.5	1.3	1.2	1.1	1.1	1	1	0.9	0.9	0.9					
35 mm	100000	3.8	3	2.6	2.1	1.7	1.5	1.4	1.2	1.1	1	0.9	0.9	0.8	0.8	0.8	0.8					
1-1/2"	10000	9.3	7.4	6.4	5.1	4.3	3.7	3.4	3	2.7	2.5	2.3	2.2	2.1	2	2						
1-9/16"	25000	6.9	5.4	4.7	3.7	3.2	2.8	2.5	2.2	2	1.8	1.7	1.6	1.6	1.5	1.4						
40 mm	50000	5.4	4.3	3.7	3	2.5	2.2	2	1.7	1.6	1.4	1.4	1.3	1.2	1.2	1.1						
	70000	4.8	3.8	3.3	2.6	2.2	1.9	1.8	1.5	1.4	1.3	1.2	1.1	1.1	1	1						
	100000	4.3	3.4	3	2.3	2	1.7	1.6	1.4	1.2	1.1	1.1	1	1	0.9	0.9						
1-5/8"	10000	10.9	8.7	7.6	6	5	4.4	4	3.5	3.2	2.9	2.8	2.6	2.5	2.4							
1-11/16"	25000	8	6.4	5.6	4.4	3.7	3.2	2.9	2.6	2.3	2.1	2	1.9	1.8	1.8							
1-3/4"	50000	6.4	5	4.4	3.5	2.9	2.6	2.3	2	1.8	1.7	1.6	1.5	1.4	1.4							
45 mm	70000	5.7	4.5	3.9	3.1	2.6	2.3	2.1	1.8	1.6	1.5	1.4	1.3	1.3	1.2							
	100000	5	4	3.5	2.8	2.3	2	1.8	1.6	1.4	1.3	1.3	1.2	1.1	1.1							
1-7/8"	10000	11.2	8.9	7.8	6.2	5.2	4.5	4.1	3.6	3.3	3	2.8	2.7	2.6								
1-15/16"	25000	8.3	6.6	5.7	4.5	3.8	3.3	3	2.6	2.4	2.2	2.1	2	1.9								
2"	50000	6.6	5.2	4.5	3.6	3	2.6	2.4	2.1	1.9	1.7	1.6	1.6	1.5								
50 mm	70000	5.9	4.6	4	3.2	2.7	2.3	2.1	1.9	1.7	1.6	1.5	1.4	1.3								
	100000	5.2	4.1	3.6	2.8	2.4	2.1	1.9	1.6	1.5	1.4	1.3	1.2	1.2								
2"	10000	13.9	11	9.6	7.6	6.4	5.6	5.1	4.4	4	3.7	3.5	3.3									
2-1/8"	25000	10.2	8.1	7.1	5.6	4.7	4.1	3.7	3.3	3	2.7	2.6	2.4									
2-3/16"	50000	8.1	6.4	5.6	4.4	3.7	3.3	3	2.6	2.3	2.2	2	1.9									
55 mm	70000	7.3	5.7	5	4	3.3	2.9	2.6	2.3	2.1	1.9	1.8	1.7									
	100000	6.4	5.1	4.4	3.5	3	2.6	2.3	2	1.8	1.7	1.6	1.5									
2-1/4"	10000	16.8	13.3	11.6	9.2	7.8	6.8	6.2	5.4	4.9	4.5	4.3	4									
2-3/8"	25000	12.4	9.8	8.6	6.8	5.7	5	4.5	4	3.6	3.3	3.1	3									
2-7/16"	50000	9.8	7.8	6.8	5.4	4.5	4	3.6	3.1	2.8	2.6	2.5	2.3									
60 mm	70000	8.8	6.9	6.1	4.8	4	3.5	3.2	2.8	2.5	2.3	2.2	2.1									
	100000	7.8	6.2	5.4	4.3	3.6	3.1	2.8	2.5	2.2	2.1	2	1.8									
2-1/2"	10000	18.4	14.6	12.7	10.1	8.5	7.4	6.7	5.9	5.3	4.9	4.7										
65 mm	25000	13.5	10.7	9.4	7.4	6.2	5.4	4.9	4.3	3.9	3.6	3.4										
	50000	10.7	8.5	7.4	5.9	4.9	4.3	3.9	3.4	3.1	2.9	2.7										
	70000	9.6	7.6	6.6	5.2	4.4	3.9	3.5	3	2.8	2.6	2.4										
	100000	8.5	6.7	5.9	4.7	3.9	3.4	3.1	2.7	2.4	2.3	2.1										
2-3/4"	10000	20	15.8	13.8	11	9.2	8.1	7.3	6.4	5.8	5.4	5.1										
70 mm	25000	14.7	11.7	10.2	8.1	6.8	5.9	5.4	4.7	4.3	4	3.7										
	50000	11.7	9.2	8.1	6.4	5.4	4.7	4.3	3.7	3.4	3.1	2.9										
	70000	10.4	8.3	7.2	5.7	4.8	4.2	3.8	3.3	3	2.8	2.6										
	100000	9.2	7.3	6.4	5.1	4.3	3.7	3.4	2.9	2.7	2.5	2.3										
2-15/16"	10000	21.6	17.2	15	11.9	10	8.7	7.9	6.9	6.3	5.8											
3"	25000	15.9	12.6	11	8.7	7.4	6.4	5.8	5.1	4.6	4.3											
75 mm	50000	12.6	10	8.7	6.9	5.8	5.1	4.6	4	3.7	3.4											
	70000	11.3	9	7.8	6.2	5.2	4.6	4.1	3.6	3.3	3											
	100000	10	7.9	6.9	5.5	4.6	4	3.7	3.2	2.9	2.7											
3-1/8"	10000	23.3	18.5	16.2	12.8	10.8	9.4	8.6	7.5	6.8	6.3											
80 mm	25000	17.2	13.6	11.9	9.4	8	6.9	6.3	5.5	5	4.6											
	50000	13.6	10.8	9.4	7.5	6.3	5.5	5	4.4	4	3.7											
	70000	12.2	9.7	8.4	6.7	5.6	4.9	4.5	3.9	3.5	3.3											
	100000	10.8	8.6	7.5	5.9	5	4.4	4	3.4	3.1	2.9											
3-1/4"	10000	27	21.4	18.7	14.8	12.5	10.9	9.9	8.7	7.9	7.3											
85 mm	25000	19.9	15.8	13.8	10.9	9.2	8	7.3	6.4	5.8	5.4											
	50000	15.8	12.5	10.9	8.7	7.3	6.4	5.8	5	4.6	4.2											
	70000	14.1	11.2	9.8	7.7	6.5	5.7	5.2	4.5	4.1	3.8											
	100000	12.5	9.9	8.7	6.9	5.8	5	4.6	4	3.6	3.4											
3-1/2"	10000	30.9	24.5	21.4	17	14.3	12.5	11.3	9.9	9												
90 mm	25000	22.7	18	15.8	12.5	10.5	9.2	8.3	7.3	6.6												
	50000	18	14.3	12.5	9.9	8.3	7.3	6.6	5.8	5.2												
	70000	16.1	12.8	11.2	8.8	7.5	6.5	5.9	5.2	4.7												
	100000	14.3	11.3	9.9	7.9	6.6	5.8	5.2	4.6	4.1												

Carga Media

Unidad : kN

TAMAÑO DEL EJE		Carga Radial permitida (kN) a diferentes RPM																	
		L ₁₀ horas	RPM (min ⁻¹)																
			50	100	150	300	500	750	1000	1500	2000	2500	3000	3500	4000	4500	5000	5500	6000
1" 25 mm	10000	6.2	4.9	4.3	3.4	2.9	2.5	2.3	2	1.8	1.7	1.6	1.5	1.4	1.4	1.3	1.3	1.2	
	25000	4.6	3.6	3.2	2.5	2.1	1.8	1.7	1.4	1.3	1.2	1.1	1.1	1	1	0.9	0.9	0.9	
	50000	3.6	2.9	2.5	2	1.7	1.4	1.3	1.1	1	0.9	0.9	0.8	0.8	0.8	0.7	0.7	0.7	
	70000	3.2	2.6	2.2	1.8	1.5	1.3	1.2	1	0.9	0.8	0.8	0.7	0.7	0.7	0.7	0.6	0.6	
	100000	2.9	2.3	2	1.6	1.3	1.1	1	0.9	0.8	0.7	0.7	0.6	0.6	0.6	0.6	0.5		
1-3/16" 1-1/4" 30 mm	10000	8.2	6.5	5.7	4.5	3.8	3.3	3	2.6	2.4	2.2	2.1	2	1.9	1.8	1.7	1.7		
	25000	6	4.8	4.2	3.3	2.8	2.4	2.2	1.9	1.7	1.6	1.5	1.4	1.4	1.3	1.3	1.2		
	50000	4.8	3.8	3.3	2.6	2.2	1.9	1.7	1.5	1.4	1.3	1.2	1.1	1.1	1	1	1		
	70000	4.3	3.4	3	2.3	2	1.7	1.5	1.3	1.2	1.1	1.1	1	1	0.9	0.9	0.9		
	100000	3.8	3	2.6	2.1	1.7	1.5	1.4	1.2	1.1	1	0.9	0.9	0.8	0.8	0.8	0.8		
1-3/8" 1-7/16" 35 mm	10000	9.3	7.4	6.4	5.1	4.3	3.7	3.4	3	2.7	2.5	2.3	2.2	2.1	2	2	2		
	25000	6.9	5.4	4.7	3.7	3.2	2.8	2.5	2.2	2	1.8	1.7	1.6	1.6	1.5	1.4	1.4		
	50000	5.4	4.3	3.7	3	2.5	2.2	2	1.7	1.6	1.4	1.4	1.3	1.2	1.2	1.1	1.1		
	70000	4.8	3.8	3.3	2.6	2.2	1.9	1.8	1.5	1.4	1.3	1.2	1.1	1.1	1	1	1		
	100000	4.3	3.4	3	2.3	2	1.7	1.6	1.4	1.2	1.1	1.1	1	1	0.9	0.9	0.9		
1-1/2" 40 mm	10000	10.9	8.7	7.6	6	5	4.4	4	3.5	3.2	2.9	2.8	2.6	2.5	2.4				
	25000	8	6.4	5.6	4.4	3.7	3.2	2.9	2.6	2.3	2.1	2	1.9	1.8	1.8				
	50000	6.4	5	4.4	3.5	2.9	2.6	2.3	2	1.8	1.7	1.6	1.5	1.4	1.4				
	70000	5.7	4.5	3.9	3.1	2.6	2.3	2.1	1.8	1.6	1.5	1.4	1.3	1.3	1.2				
	100000	5	4	3.5	2.8	2.3	2	1.8	1.6	1.4	1.3	1.3	1.2	1.1	1.1				
1-3/4" 45 mm	10000	11.2	8.9	7.8	6.2	5.2	4.5	4.1	3.6	3.3	3	2.8	2.7	2.6					
	25000	8.3	6.6	5.7	4.5	3.8	3.3	3	2.6	2.4	2.2	2.1	2	1.9					
	50000	6.6	5.2	4.5	3.6	3	2.6	2.4	2.1	1.9	1.7	1.6	1.6	1.5					
	70000	5.9	4.6	4	3.2	2.7	2.3	2.1	1.9	1.7	1.6	1.5	1.4	1.3					
	100000	5.2	4.1	3.6	2.8	2.4	2.1	1.9	1.6	1.5	1.4	1.3	1.2	1.2					
1-15/16" 2" 50 mm	10000	13.9	11	9.6	7.6	6.4	5.6	5.1	4.4	4	3.7	3.5	3.3						
	25000	10.2	8.1	7.1	5.6	4.7	4.1	3.7	3.3	3	2.7	2.6	2.4						
	50000	8.1	6.4	5.6	4.4	3.7	3.3	3	2.6	2.3	2.2	2	1.9						
	70000	7.3	5.7	5	4	3.3	2.9	2.6	2.3	2.1	1.9	1.8	1.7						
	100000	6.4	5.1	4.4	3.5	3	2.6	2.3	2	1.8	1.7	1.6	1.5						
2-3/16" 2-1/4" 55 mm	10000	16.8	13.3	11.6	9.2	7.8	6.8	6.2	5.4	4.9	4.5	4.3	4						
	25000	12.4	9.8	8.6	6.8	5.7	5	4.5	4	3.6	3.3	3.1	3						
	50000	9.8	7.8	6.8	5.4	4.5	4	3.6	3.1	2.8	2.6	2.5	2.3						
	70000	8.8	6.9	6.1	4.8	4	3.5	3.2	2.8	2.5	2.3	2.2	2.1						
	100000	7.8	6.2	5.4	4.3	3.6	3.1	2.8	2.5	2.2	2.1	2	1.8						
2-7/16" 60 mm	10000	18.4	14.6	12.7	10.1	8.5	7.4	6.7	5.9	5.3	4.9	4.7							
	25000	13.5	10.7	9.4	7.4	6.2	5.4	4.9	4.3	3.9	3.6	3.4							
	50000	10.7	8.5	7.4	5.9	4.9	4.3	3.9	3.4	3.1	2.9	2.7							
	70000	9.6	7.6	6.6	5.2	4.4	3.9	3.5	3	2.8	2.6	2.4							
	100000	8.5	6.7	5.9	4.7	3.9	3.4	3.1	2.7	2.4	2.3	2.1							
2-1/2" 65 mm	10000	20	15.8	13.8	11	9.2	8.1	7.3	6.4	5.8	5.4	5.1							
	25000	14.7	11.7	10.2	8.1	6.8	5.9	5.4	4.7	4.3	4	3.7							
	50000	11.7	9.2	8.1	6.4	5.4	4.7	4.3	3.7	3.4	3.1	2.9							
	70000	10.4	8.3	7.2	5.7	4.8	4.2	3.8	3.3	3	2.8	2.6							
	100000	9.2	7.3	6.4	5.1	4.3	3.7	3.4	2.9	2.7	2.5	2.3							
2-3/4" 70 mm	10000	21.6	17.2	15	11.9	10	8.7	7.9	6.9	6.3	5.8								
	25000	15.9	12.6	11	8.7	7.4	6.4	5.8	5.1	4.6	4.3								
	50000	12.6	10	8.7	6.9	5.8	5.1	4.6	4	3.7	3.4								
	70000	11.3	9	7.8	6.2	5.2	4.6	4.1	3.6	3.3	3								
	100000	10	7.9	6.9	5.5	4.6	4	3.7	3.2	2.9	2.7								
2-15/16" 3" 75 mm	10000	23.3	18.5	16.2	12.8	10.8	9.4	8.6	7.5	6.8	6.3								
	25000	17.2	13.6	11.9	9.4	8	6.9	6.3	5.5	5	4.6								
	50000	13.6	10.8	9.4	7.5	6.3	5.5	5	4.4	4	3.7								
	70000	12.2	9.7	8.4	6.7	5.6	4.9	4.5	3.9	3.5	3.3								
	100000	10.8	8.6	7.5	5.9	5	4.4	4	3.4	3.1	2.9								
80 mm	10000	27	21.4	18.7	14.8	12.5	10.9	9.9	8.7	7.9	7.3								
	25000	19.9	15.8	13.8	10.9	9.2	8	7.3	6.4	5.8	5.4								
	50000	15.8	12.5	10.9	8.7	7.3	6.4	5.8	5	4.6	4.2								
	70000	14.1	11.2	9.8	7.7	6.5	5.7	5.2	4.5	4.1	3.8								
	100000	12.5	9.9	8.7	6.9	5.8	5	4.6	4	3.6	3.4								
3-7/16" 85 mm	10000	30.9	24.5	21.4	17	14.3	12.5	11.3	9.9	9									
	25000	22.7	18	15.8	12.5	10.5	9.2	8.3	7.3	6.6									
	50000	18	14.3	12.5	9.9	8.3	7.3	6.6	5.8	5.2									
	70000	16.1	12.8	11.2	8.8	7.5	6.5	5.9	5.2	4.7									
	100000	14.3	11.3	9.9	7.9	6.6	5.8	5.2	4.6	4.1									
90 mm	10000	35	27.8	24.3	19.3	16.2	14.2	12.9	11.2	10.2									
	25000	25.8	20.5	17.9	14.2	11.9	10.4	9.5	8.3	7.5									
	50000	20.5	16.2	14.2	11.2	9.5	8.3	7.5	6.6	6									
	70000	18.3	14.5	12.7	10	8.5	7.4	6.7	5.9	5.3									
	100000	16.2	12.9	11.2	8.9	7.5	6.6	6	5.2	4.7									
3-15/16" 4" 100 mm	10000	42.8	33.9	29.6	23.5	19.8	17.3	15.7	13.7	12.5									
	25000	31.5	25	21.8	17.3	14.6	12.7	11.6	10.1	9.2									
	50000	25	19.8	17.3	13.7	11.6	10.1	9.2	8	7.3									
	70000	22.3	17.7	15.5	12.3	10.3	9	8.2	7.2	6.5									
	100000	19.8	15.7	13.7	10.9	9.2	8	7.3	6.3	5.8									

1. Los datos sobre fondo gris se refieren a un sellado sin contacto.

Si el rodamiento con tornillos prisioneros está expuesto a una carga pesada (Pr / Cr > 0.12), vibraciones o fuertes impactos, utilizar una tolerancia del eje más ajustada de lo normal.



Apéndice: Tabla Carga Radial / Velocidad

Carga Pesada

Unidad : kN

TAMAÑO DEL EJE	L10 horas	Carga Radial permitida (kN) a diferentes RPM																
		RPM (min ⁻¹)																
		50	100	150	300	500	750	1000	1500	2000	2500	3000	3500	4000	4500	5000	5500	6000
1" 25 mm	10000	6.8	5.4	4.7	3.7	3.1	2.7	2.5	2.1	1.9	1.8	1.7	1.6	1.5	1.5	1.4	1.3	1.3
	25000	5	3.9	3.4	2.7	2.3	2	1.8	1.6	1.4	1.3	1.2	1.2	1.1	1.1	1	1	0.9
	50000	3.9	3.1	2.7	2.1	1.8	1.6	1.4	1.2	1.1	1	0.9	0.9	0.8	0.8	0.8	0.8	0.7
	70000	3.5	2.8	2.4	1.9	1.6	1.4	1.3	1.1	1	0.9	0.9	0.8	0.8	0.7	0.7	0.7	0.7
	100000	3.1	2.5	2.1	1.7	1.4	1.2	1.1	1	0.9	0.8	0.8	0.7	0.7	0.6	0.6	0.6	0.6

TAMAÑO DEL EJE	L10 horas	Carga Radial permitida (kN) a diferentes RPM															
		RPM (min ⁻¹)															
		50	100	150	300	500	750	1000	1500	2000							
80 mm	10000	39.5	31.4	27.4	21.7	18.3	16	14.5	12.7	11.5							
	25000	29.1	23.1	20.2	16	13.5	11.8	10.7	9.3	8.5							
	50000	23.1	18.3	16	12.7	10.7	9.3	8.5	7.4	6.7							
	70000	20.6	16.4	14.3	11.3	9.6	8.3	7.6	6.6	6							
	100000	18.3	14.5	12.7	10.1	8.5	7.4	6.7	5.9	5.3							

1. Los datos sobre fondo gris se refieren a un sellado sin contacto.

Si el rodamiento con tornillos prisioneros está expuesto a una carga pesada (Pr / Cr > 0.12), vibraciones o fuertes impactos, utilizar una tolerancia del eje más ajustada de lo normal.

Cálculos de vida de los rodamientos de bolas

La relación entre la duración de la vida nominal, la capacidad de carga dinámica y la carga dinámica equivalente del rodamiento de bolas está indicada en la Formula 1. Si la unidad de rodamiento se utiliza a una velocidad de rotación fija, la vida está indicada como tiempo (Formula 2).

$$1. L_{10} = \left(\frac{C_r}{P_r} \right)^3$$

L10 : Duración Vida Nominal
10⁶ rotaciones

$$2. L_{10h} = \frac{10^6 L_{10}}{60n} = \frac{10^6}{60n} \cdot \left(\frac{C_r}{P_r} \right)^3$$

L10h : Vida útil (hr)

Cr : Capacidad de Carga Dinámica (kN)
Pr : Carga Dinámica equivalente (kN)
n : Velocidad (min⁻¹)

Cargas Básicas (kN)		
TAMAÑO	Carga Dinámica	Carga Estática
UC201	12.8	6.65
UC202	12.8	6.65
UC203	12.8	6.65
UC204	12.8	6.65
UC205	14.0	7.85
UC206	19.5	11.3
UC207	25.7	15.4
UC208	29.1	17.8
UC209	34.1	21.3
UC210	35.1	23.3
UC211	43.4	29.4
UC212	52.4	36.2
UC213	57.2	40.1
UC214	62.2	44.1
UC215	67.4	48.3
UC216	72.7	53.0
UC217	84.0	61.9
UC218	96.1	71.5

Cargas Básicas (kN)		
TAMAÑO	Carga Dinámica	Carga Estática
UC305	21.2	10.9
UC306	26.7	15.0
UC307	33.4	19.3
UC308	40.7	24.0
UC309	48.9	29.5
UC310	62.0	38.3
UC311	71.6	45.0
UC312	81.9	52.2
UC313	92.7	59.9
UC314	104	68.2
UC315	113	77.2
UC316	123	86.7
UC317	133	96.8
UC318	143	107
UC319	153	119
UC320	173	141
UC321	184	153
UC322	205	180
UC324	207	185
UC326	229	214
UC328	253	246

Cargas Básicas (kN)		
TAMAÑO	Carga Dinámica	Carga Estática
UCX05	19.5	11.3
UCX06	25.7	15.4
UCX07	29.1	17.8
UCX08	34.1	21.3
UCX09	35.1	23.3
UCX10	43.4	29.4
UCX11	52.4	36.2
UCX12	57.2	40.1
UCX13	62.2	44.1
UCX14	67.4	48.3
UCX15	72.7	53.0
UCX16	84.0	61.9
UCX17	96.1	71.5
UCX18	109	81.9
UCX20	133	105



Rodamientos de rodillos esféricos

Más de sesenta años de experiencia e innovación en el sector de los rodamientos de bolas ha llevado a la fabricación de rodamientos de rodillos esféricos que se adaptan a una amplia gama de aplicaciones e industrias. FYH se encarga del entero proceso de fabricación tanto de los rodamientos como de los soportes, y para ello utiliza sólo los mejores materiales a disposición. Gracias a meticulosas mejoras en el diseño y a una cuidadosa selección de los materiales, esta serie de rodamientos de rodillos, diseñada para cargas pesadas, obtiene la designación de "EXTRA RESISTENTE".

EXTRA RESISTENTE

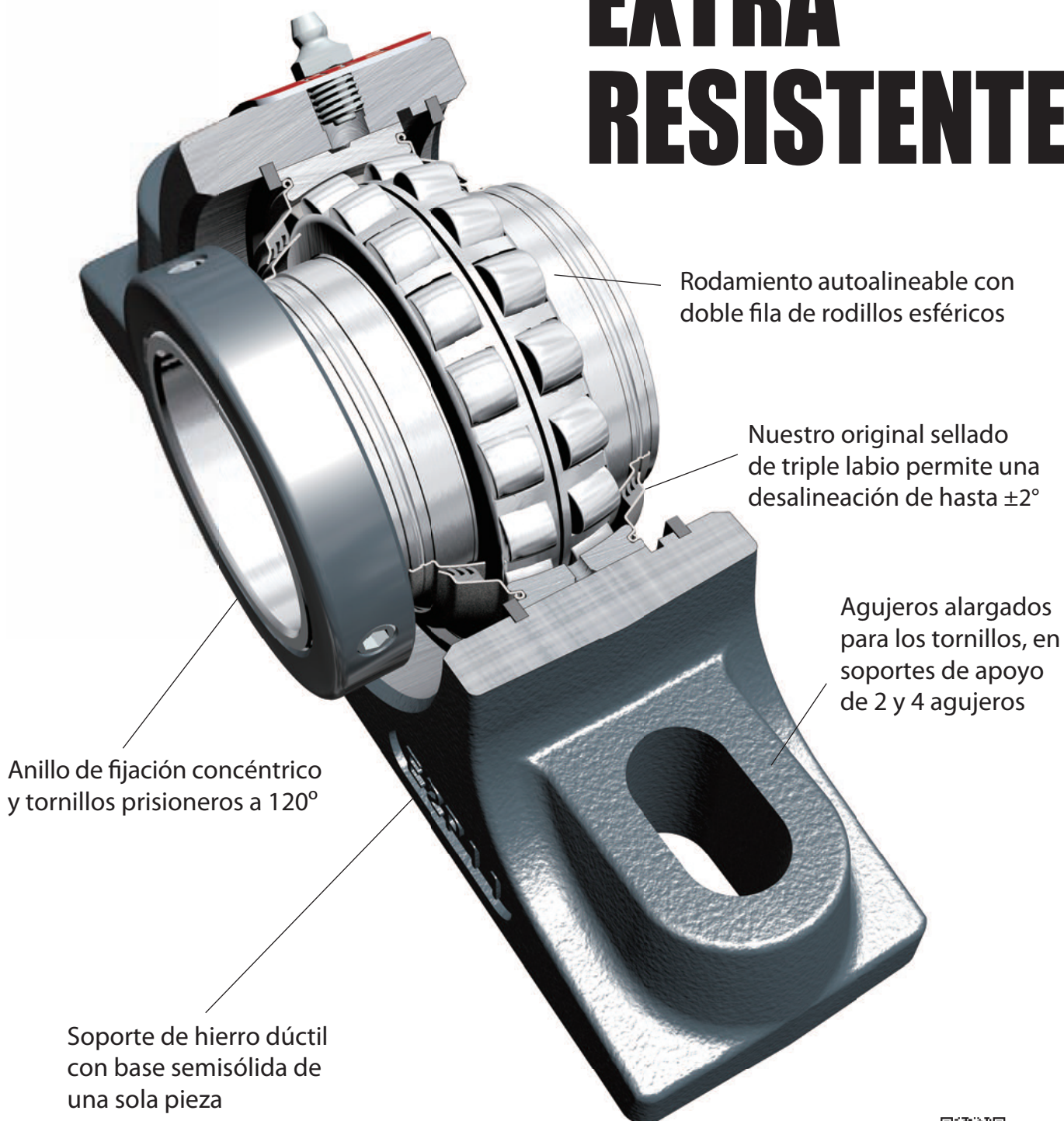



LOCK

Es el sistema de cierre más revolucionario del mercado: más rápido, más fácil y con un máximo poder de sujeción.

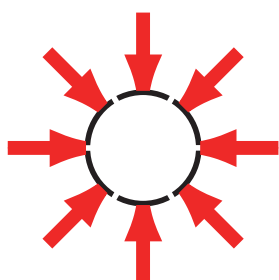
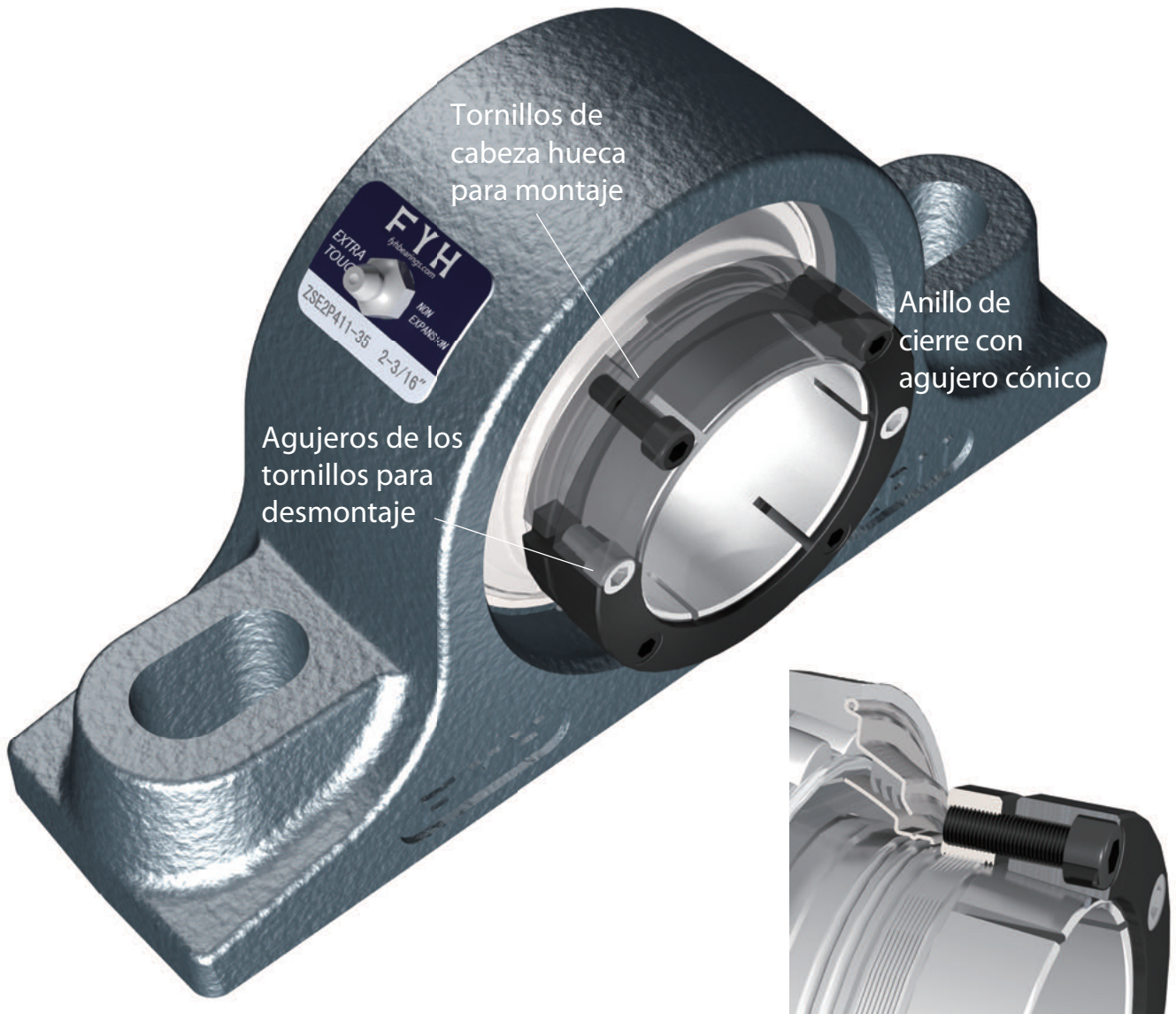

EL SISTEMA DE CIERRE
MÁS REVOLUCIONARIO
AGARRE REAL 360°





FYH BEARING UNITS USA INC.

13201 FYH Drive Huntley, Illinois 60142, USA
TEL: +1-847-487-9111 FAX: +1-847-487-9222 E-mail: sales@fyhusa.com

NIPPON PILLOW BLOCK CO., LTD.

HEAD OFFICE/Main Plant

2306 Hirao Miharaku Sakai Osaka 587-0022 JAPAN
TEL: 072-361-3750 FAX: 072-361-4173 E-mail: info@fyhbearings.com
E-mail: exports@fyh.co.jp
www.fyhbearings.com/

fyhbearings.com

