

0 50 100 (mm)参考

FYH

参考図

0
50
100

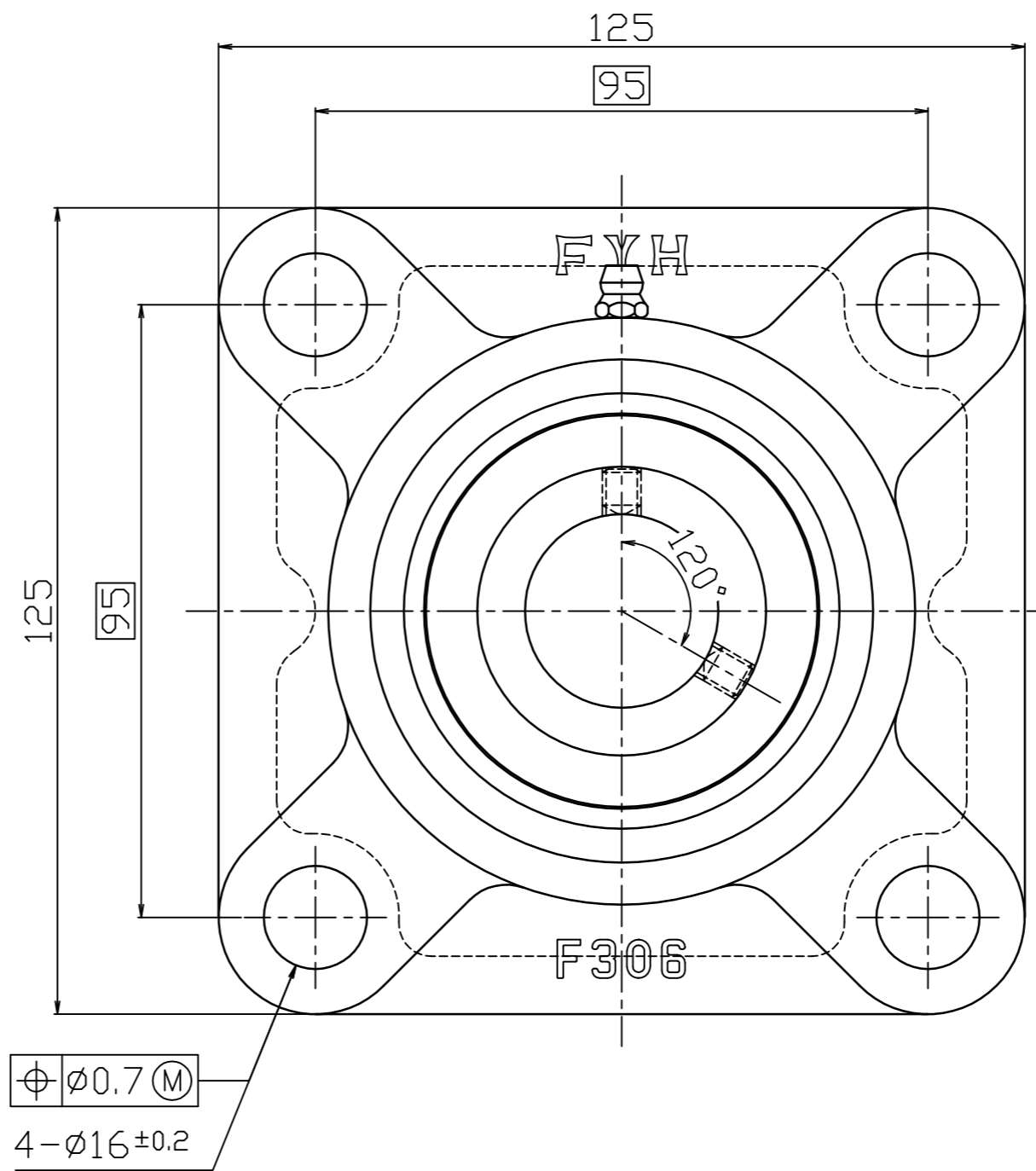
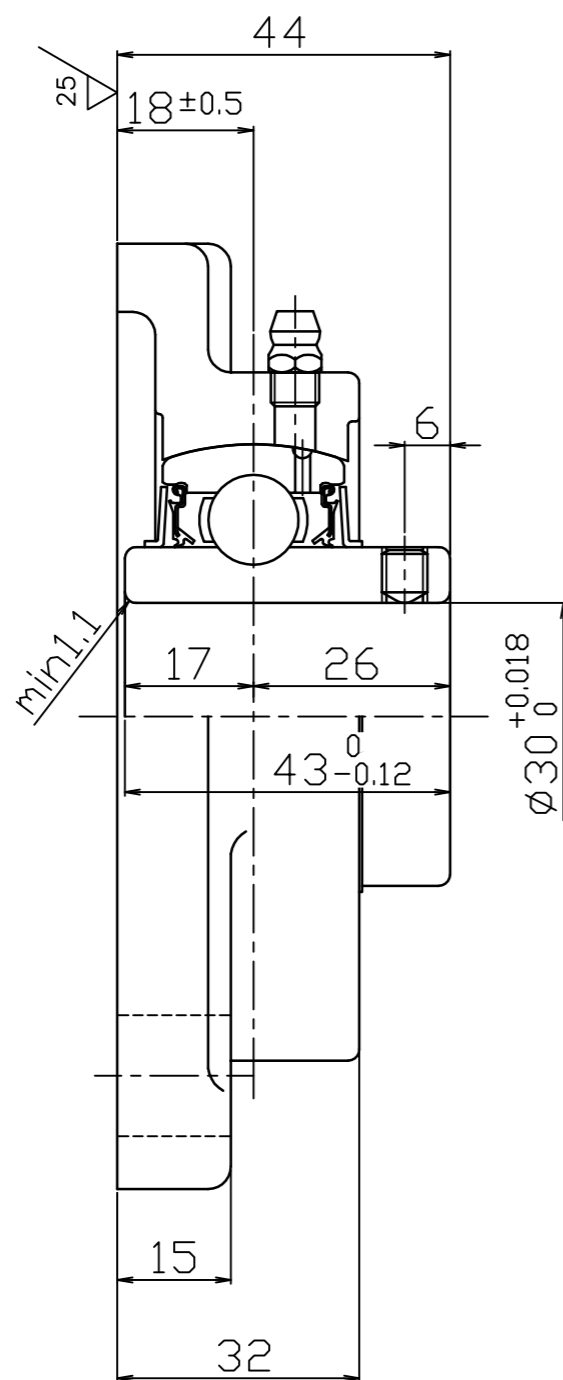

FYH株式会社	
呼び番号	UCF306J
図番	参考図