

0 50 100 (mm)参考

FYH

参考図

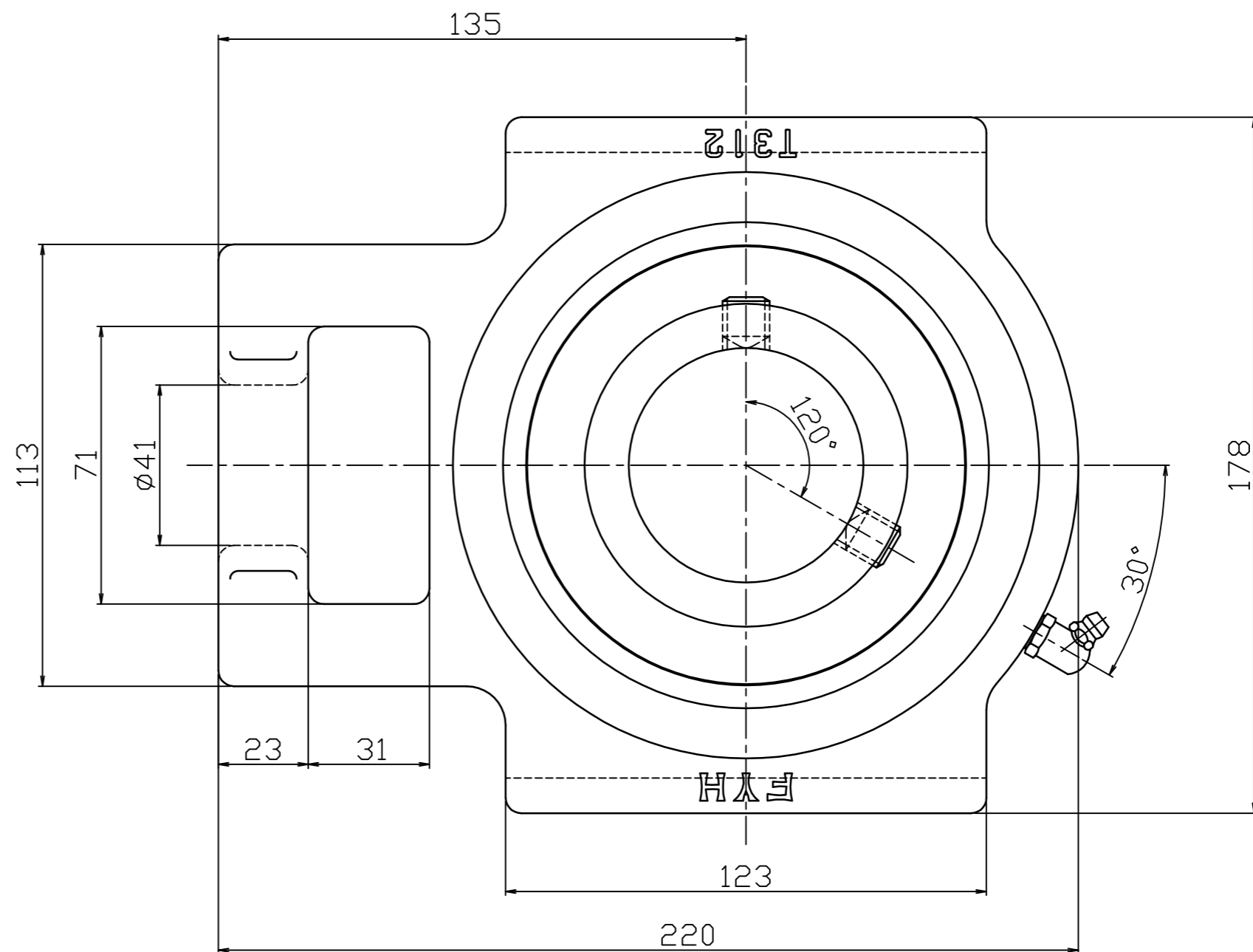
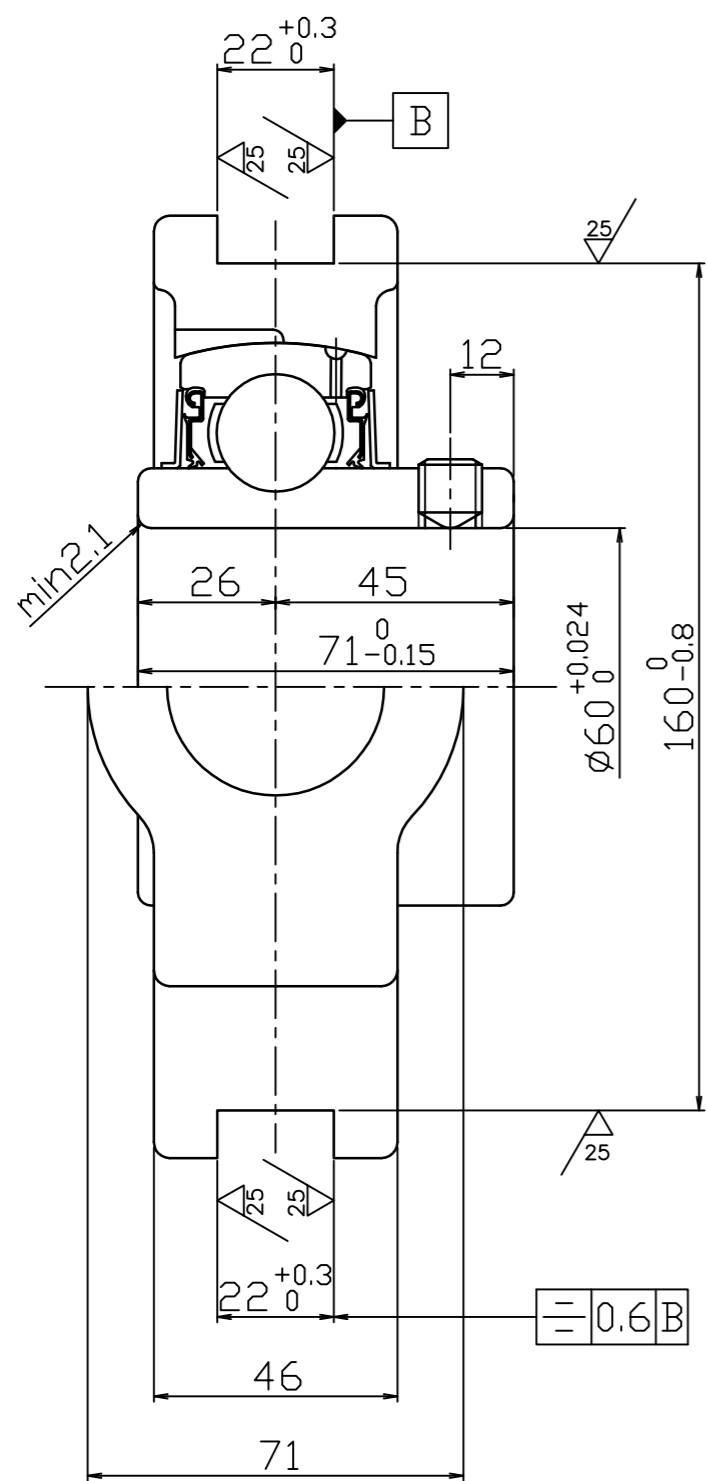

FYH株式会社	
呼び番号	UCT312
図番	参考図